

# PILAT & PILAT

## PRICES 2023

### International

**EXCL. VAT**

#### **content**

- 1 PRODUCT INFORMATION
- 7 TABLES
- 33 COFFEE TABLES & SMALL TABLES
- 45 DESKS
- 51 BENCHES
- 65 ARMCHAIRS & CHAIRS
- 79 CABINETS, SIDEBOARDS & SHELVING UNITS

**WWW.PILAT.NL**

# PRODUCTION PROCES

## OWN MANUFACTURING PLANT IN BOSNIA

All furniture and wooden home accessories from Pilat&Pilat are produced at Nordent. They have their own manufacturing plant in Bosnia Herzegovina, employing some 60 craftspeople on a full-time basis. Pilat&Pilat like to buy their wood privately from small-scale operators. For many generations, orchards have been a sustainable source of income for the elderly in the woody regions of Bosnia. On average, families have about two hectares of woodland with dozens of fruit trees, such as walnut and cherry trees. After many years of harvesting the fruits, the trees are finally given the chop. Three trees will get a family, often consisting of three generations, comfortably through winter. The younger generation always takes care of new plantings and the maintenance of the orchard. A personal hallmark of care and dedication is automatically passed on to the growing wood from one generation to the next.

FROM FAMILY ORCHARD TO 'FAMYLJE' COLLECTION. A SUSTAINABLE AND SENSIBLE PROCESS.

## SUSTAINABLE WOOD SELECTION

The solid wooden furniture of the 'Famylje' Collection revolves around three types of wood: oak, light elm and walnut. The unique character of the tree is retained in each piece of furniture. In terms of appearance, no two pieces of the same type of furniture are exactly identical, because of a different shade, for instance.

For the Famylje Collection, a furniture maker will endeavour to create the best possible balance by choosing the right wood. A customer with special requirements with regard to the preferred furniture wood is advised to first talk to his dealer. In many cases, it would be desirable to match the appearance of new furniture to the customer's preference. Colour and structure are variables for the customer to choose from. The furniture maker will do his best to meet the customer's choice. However, this may result in an extra charge. As was pointed out, the procedure of purchasing wood in Bosnia is quite different from the methods followed by Dutch furniture manufacturers, who buy their wood from wholesalers. We buy a certain quality of wood as required, at a price to match. Pilat&Pilat and Nordent take responsibility for the environment by using the large pieces of high-quality wood for making furniture. Smaller pieces, left over after selecting and manufacturing furniture, are used for the production of home accessories. Any remaining wood is used for heating the dry kilns and the furniture plant. In this process, native trees from wooded Bosnia are being used in a sustainable manner.

## TAILORED TO SUIT INDIVIDUAL REQUIREMENTS

The furniture quality is continuously monitored during the entire production process. Each piece of furniture is custom-made of the type of wood chosen by the customer. Please contact us for a price of nonstandard items. In addition to deviating sizes, alternative tabletop patterns and details such as a bevel or a rounding of the table top are possible.



# FINISH OPPORTUNITIES OF SOLID WOOD

## THREE WOOD TYPES CENTRAL

The solid wooden furniture of the Pilat&Pilat Famylje Collection revolves around three types of wood; oak, walnut and light elm. The unique character of the tree is retained in each piece of furniture. That is the reason why no two pieces of furniture are exactly identical, but will differ in things like colour shade. The wood is selected and processed by experienced furniture makers in our own factory in Bosnia. Our furniture quality is continuously monitored during the entire production process. Each piece of furniture is custom-made of the type of wood chosen by the customer. The wood is finished using natural oil, furniture soap or a laquer.

## BEECH WOOD

From January 2023 we now also offer the wood type beech for a selected number of collection models. Beech wood has an even structure with little drawing and wide plank parts are possible. This gives a beech wood piece of furniture a calm, light appearance.

## WOODEN SAMPLE BOX

The solid wooden furniture have several possible finishes. Depending on the appearance and maintenance, a finish that suits the user can be chosen. The furniture can be finished with natural oil and / or soap, which gives the wood a soft, natural look. Furthermore, a lacquer, possibly in combination with a stain or paint finish can be chosen. The sample material provides insight into the options available.

## MATERIAL SAMPLES AND FINISHES

An overview of the wood samples and finishes can be found on our website [www.pilat.nl](http://www.pilat.nl). At the bottom of the footer, click on 'Wood samples and finishes' for an overview of the wood samples with the various finishes and the basic colors that we use for coated steel. This also applies to the standard colors of sheep leather and cow leather that we offer.



# PROPERTIES OF SOLID WOOD

## WOOD IS A PRODUCT OF NATURE

Due to the natural nature, the color and structure of the furniture are never identical. In spite of the treatment, the colour of the wood may change over time due to influences of sunlight and artificial light. Wood has an open structure. As a result, exposure to humidity in the air may have an effect on the furniture. Changes may occur at any time. Particularly during winter months when heaters are turned on full power, the air may become too dry for the wood.

To minimise the risk of warping of the wood, we suggest a healthy indoor climate with a room temperature of approx. 20 degrees Celsius and a relative air humidity of around 50% - 60%. Dry air may cause minute cracks in the wood, which will close again as the humidity level goes up. A natural product such as wood can shrink and expand. This is kept to a minimum with a constant relative humidity of around 50%. This prevents cracks in your wooden furniture. If you have already discovered cracks in your wooden furniture, maintain your furniture extra and wait for the period of freezing cold to end. Usually the cracks disappear by themselves when the humidity is back to normal.

## WOOD IS A HIGH-GRADE MATERIAL

Wood needs to be treated with care. Sharp, hot or wet objects may damage the wooden surface. Spilt liquids should be removed immediately to prevent stains. The use of caustic - and certainly abrasive - cleaning agents is not recommended. Many stains can be prevented by using coasters and by shorten the exposure time of the stain by removing it in time. With the correct maintenance of oiled and soaped furniture you can avoid that stains can penetrate the wood.

## SMALL DO-IT-YOURSELF REPAIRS

The advantage of unpainted and not artificially coloured solid furniture is to have the routine maintenance and small repairs in your own hands. Permanent and serious stains, such as traces of regular touching or rubber shoes on table legs, can be removed using fine (400-grit) sandpaper. Make sure you sand lengthwise in the direction of the wood grain. This will remove the film of oil or soap that had been put on for protection. Remember to re-apply the surface protection after treatment. A deep scratch or dent may be repaired through sanding or swelling (briefly pressing a hot iron onto a moist cloth on the damaged spot). In that way it will be a breeze to repair small damage to your furniture without expert knowledge.

## IN A NUTSHELL:

- Prevent discoloration by keeping your furniture away from permanent sunlight.
- Keep some distance between your furniture and the heat source (heater or heat pump), to prevent the wood from drying out.
- Get yourself a hygrometer and keep the relative air humidity indoors between 50% and 60%.
- Use coasters or placemats to prevent rings from cups and glasses.
- Be careful with porous vases and flower pots, these can leave irreparable circles behind.

## WHEN WINTER COMES

To prevent cracks in your furniture in winter due to a dry indoor climate, you can do the following:

- Place a humidifier.
- Maintain your furniture with soap (or oil) more often
- Ventilate your house sufficiently.

# MAINTENANCE WITH OIL

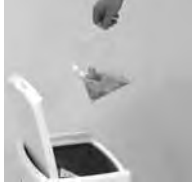

Use a moist cloth for everyday cleaning of the furniture.

Maintenance with oil is carried out every six months or annually, depending on use.

When using the white-pigmented maintenance oil, remember to shake the bottle (and possibly stir the fluid) to ensure the white pigment and the oil are mixed well.

Apply a small amount of maintenance oil to a cotton cloth and rub into the wood.

Allow drying for 20 minutes: rub the furniture dry with a clean cotton cloth in the direction of the wood grain. Repeat the treatment after approx. 40 minutes.

The furniture may only be used normally after 4 hours. After treatment with maintenance oil, the wood on the treated areas should not come into contact with water for 24 hours to allow the undisturbed curing process. Use coasters during this time.

**Warning:**

*after use, remember to rinse the cotton cloth that has been used to rub in the maintenance oil and let it dry in the open air. Alternatively, dip the cloth into water, put it into a plastic bag and throw it away. That is to avoid the risk of spontaneous combustion.*

Maintenance products such as soap and oil can be ordered at your dealer or via an email to [pilat@pilat.nl](mailto:pilat@pilat.nl).

- |                                 |        |         |
|---------------------------------|--------|---------|
| • bottle of natural oil         | 250 ml | € 10,-* |
| • bottle of white pigmented oil | 250 ml | € 10,-* |
| • bottle of brown oil           | 250 ml | € 10,-* |
| • bottle of black oil           | 250 ml | € 10,-* |

\* excluding shipping, prices may vary by country

The natural oils used for Pilat&Pilat furniture enhance the structure and the colour of the wood and create a strong and abrasion-proof surface. The special composition of the oil ensures the "breathing" ability of the wood. That is the reason why the wood is resilient and durable, while it retains its natural properties.

By using the furniture, the oil layer can become worn. In that case you may wish to bring the furniture 'back to life' using the maintenance oil supplied (natural or white-pigmented). The maintenance oil repairs the original film of oil and gives a silky, resilient and dirt and water resistant layer.

Content maintenance box:

- 250 ml maintenance oil (white pigmented, natural or brown)
- polishing cloth
- plastic bag
- sandpaper
- maintenance recommendation

## IMPORTANT:

**Pilat&Pilat-Furniture treated with oil will require an 8 to 10 - week curing period. In this time, the wood will be covered with a protective layer. We advise against the intensive use of the furniture in this period.**

**• Do NOT treat your furniture with maintenance oil for the first 8 - 10 weeks.**

**• Protect your oiled furniture against moisture by using coasters.**

# MAINTENANCE WITH SOAP



## Normal maintenance

Put 1 part soap in a jar or bottle and add 10 parts water to it. Apply the mixture to a clean, damp microfibre cloth and rub the furniture in the direction of the wood grain. Leave for 2 minutes and then wipe the furniture with a slightly damp cloth.

The maintenance with soap should be repeated, depending on the usage and to what extent the furniture is dirty:

- **dining and coffee tables:** once every 1 to 3 weeks (clean regularly along the legs of your furniture too, to avoid colour differences)
- **dressers and closets:** once every 1 to 3 months

Before using a mixture of white pigmented soap, stir or shake the mixture well to mix the white pigment with soap.

It is advisable to keep this mixture in a closable bottle or spray bottle, ready for use.

Apply the mixture with a cloth (dish cloth or microfibre cloth) and soap the whole piece of furniture in the direction of the woodgrain. Let it soak for about 2 minutes.

Then wipe the furniture with a clean, damp cloth removing excess soap and dirt. The water will evaporate very rapidly, leaving a new layer of soap in the wood.

It can occur, especially in oak, that the wood fibers open after the first maintenance with soap. The furniture then feels rough. In the maintenance box you will find a piece of sandpaper 400. Then sand, in the length of the wood grain, the surface soft again.

Maintenance products such as soap and oil can be ordered at your dealer or via an email to [pilat@pilat.nl](mailto:pilat@pilat.nl).

- bottle of natural soap 250 ml € 10,-\*
- bottle of white pigmented soap 250 ml € 10,-\*

## FOR PERSISTENT STAINS

- Super stain remover 250 ml € 18.95\*
- Stain spray (oak) 250 ml € 19.95\*

\* excluding shipping, prices may vary by country

Soap as a maintenance agent for wooden furniture works in two ways. Firstly, soap acts preventively. After each soap treatment, a saturation of the surface by the coconut and soy grease follows, disallowing dirt and moisture are to penetrate into the wood. Secondly, the soap also works as a cleaning agent by removing the dirt in the upper layer of the wood. When a soaped furniture is delivered to you, it is pre-treated with an extra protective layer and then soaped several times. It is recommended to maintain the furniture regularly with soap.

The soap (white pigmented or natural) is manufactured from raw plant materials without the use of colors, fragrances, preservatives or other artificial additives.

The soap is highly concentrated and has to be diluted with water prior to application to the wood (1 part soap to 10 parts water). The higher the concentration of soap, the whiter / paler the wood becomes or remains. As you apply the soap more often, the wood will become or remain more white or pale. The wood is therefore better protected.

## Maintenance for dirt and stains

Apply the diluted soap to the rough side of a scouring pad. Then sand the stain with light pressure in the direction of the wood grain. Then wipe the area with a clean, damp cloth. Repeat this for stubborn stains. The furniture should dry between treatments. Then soap the furniture according to normal instructions with a damp cloth.

Difficult stains, such as greasiness and red wine, can be removed by applying a small amount of diluted soap to the stain and covering it with a damp cloth and allowing the soap to work for about 10-12 hours. Then soap the surface again.

## Content maintenance box:

- bottle of 250ml maintenance soap (white or natural)
- scourer
- sandpaper
- maintenance instructions

# MAINTENANCE OF LACQUERED SURFACES

In addition to the treatment with oil and soap, Pilat&Pilat offers a lacquer finish. A transparent lacquer can be combined with a stain. Furthermore, oak can be sprayed in a color lacquer, whereby the structure of the wood remains visible. In addition to the standard color lacquers, a lacquer finish is possible in almost any RAL or Sikkens color.

A lacquer closes the wood in such a way that air humidity differences have less influence on the operation of the wood. Furthermore, lacquering is practical: the furniture can easily be removed with a duster or slightly damp cloth (not too wet). Do not use in the treatment of stains abrasives, only mild soapy water.

**Important: do not let liquids lie down but remove within 10 to 15 minutes. Use coasters and do not put any hot objects on the furniture, this will give stains that can not be removed.**

Be careful with porous vases and flower pots, these can leave irreparable circles. Under glass with cool drinks, condensation can form under the bottom. That is why it is good to use coasters.

A lacquered furniture feels different than a furniture with oil or soap finish. Due to the paint the contact with the wood disappears for the user. Any damage is more difficult to solve. Where in a soap or oil finish a piece of furniture can be updated without visible traces, a lacquered piece of furniture will often have to be completely sanded and re-sprayed.

# TABLES

prices 2023 in euro excl. VAT

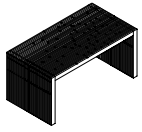

**BAS**  
page 8

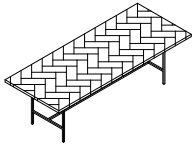

**BRUGT**  
page 9

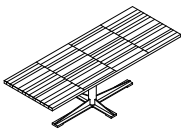

**DIRK-JISK**  
RECTANGULAR/  
SQUARE  
page 10



**DIRK-JISK**  
OVAL/ROUND  
page 11

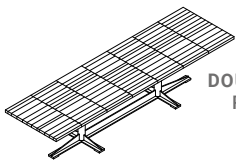

**DIRK-JISK**  
DOUBLE SUPPORT  
RECTANGULAR  
page 12

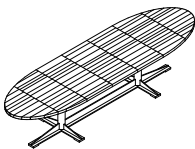

**DIRK-JISK**  
DOUBLE SUPPORT  
OVAL WITH  
STRAIGHT SIDES  
page 13



**DJURRE**  
page 14

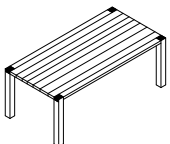

**DORUS**  
page 15



**ELIZABETH**  
page 16

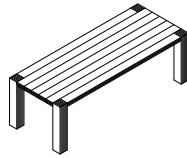

**HINDRIK**  
LANGSHOUT  
page 17

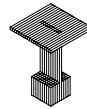

**JEHANNES**  
page 18

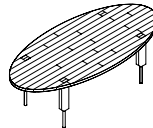

**JELLE**  
page 19

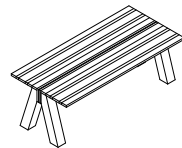

**JONAS**  
page 20

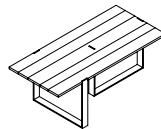

**KLAAS**  
page 21

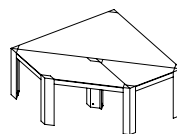

**KODAMA**  
page 22-24

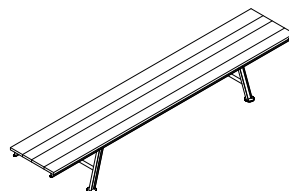

**MADS**  
page 25

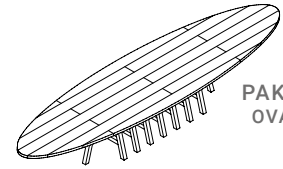

**PAKE SYTSE**  
OVAL/ROUND  
page 26

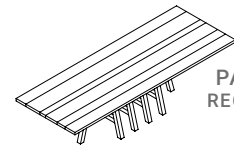

**PAKE SYTSE**  
RECTANGULAR  
page 27

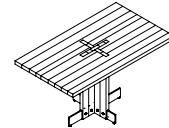

**STIEN**  
page 28

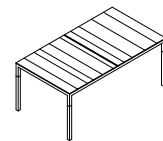

**TIEMEN I**  
page 29

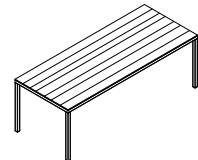

**TIEMEN II**  
page 30

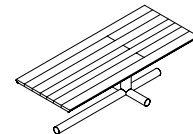

**TOM**  
page 31

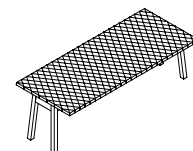

**WYBE**  
page 32



# BAS table

design: Gjal't Pilat, 2001

prices 2023 in euro excl. VAT

*custom sizes on request*

## dimensions

## L x W x H

## light elm

## oak

## walnut

## key features / additional prices

### Bas sidetable

160 x 42 x 76

1.598

1.726

1.984

- made of 6,8 cm thick wood

180 x 42 x 76

1.629

1.759

2.023

- composed of various lengths from 40 to 100 cm

200 x 42 x 76

1.658

1.791

2.059

- dining table is delivered in two parts

220 x 42 x 76

1.688

1.823

2.097

- The finishing options are according to the solid wood samples such as

240 x 42 x 76

1.718

1.856

2.134

- presented in the current sample box.

### Bas dining table

160 x 84,5 x 76

3.197

3.453

3.971

- The prices are the same for all finishes;

180 x 84,5 x 76

3.256

3.516

4.044

- soap, oil, stain-lacquer, transparant

200 x 84,5 x 76

3.315

3.580

4.117

- lacquer and color lacquer.

220 x 84,5 x 76

3.375

3.645

4.192

240 x 84,5 x 76

3.435

3.709

4.266

160 x 100,5 x 76

3.580

3.866

4.446

180 x 100,5 x 76

3.647

3.939

4.529

200 x 100,5 x 76

3.713

4.010

4.612

220 x 100,5 x 76

3.779

4.082

4.694

240 x 100,5 x 76

3.847

4.155

4.778

# BRUGT table

design: Gjalt Pilat, 2019

prices 2023 in euro excl. VAT

custom sizes on request

## dimensions

## L x W x H

## light elm

## oak

## walnut

## key features / additional prices

Brugt table

180 x 100 x 76

2.957

3.193

3.513

herringbone

200 x 100 x 76

3.041

3.284

3.613

pattern

220 x 100 x 76

3.221

3.479

3.827

240 x 100 x 76

3.436

3.711

4.082

260 x 100 x 76

3.604

3.892

4.281

280 x 100 x 76

3.781

4.083

4.492

300 x 100 x 76

4.037

4.360

4.796

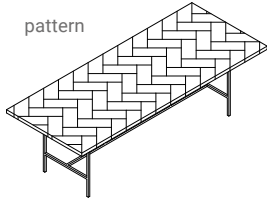

Brugt table

180 x 100 x 76

2.297

2.480

2.728

full lengths

200 x 100 x 76

2.391

2.582

2.841

220 x 100 x 76

2.563

2.768

3.045

240 x 100 x 76

2.731

2.949

3.244

260 x 100 x 76

2.907

3.139

280 x 100 x 76

3.035

3.278

300 x 100 x 76

3.187

3.442

Brugt table

260 x 100 x 76

3.453

several lengths

280 x 100 x 76

3.605

300 x 100 x 76

3.786

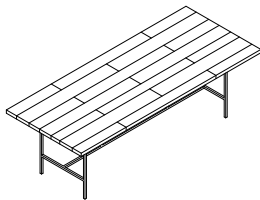

- standard table top herringbone pattern
- table top thickness is 4 cm
- The table top has an overhang of 25 cm on the short side
- Frame solid steel 2 x 2 cm
- Frame with coating in the standard colors RAL 9004 (black), RAL 9010 (white), Sikkens C4.40.30 (red), F6.05.50 (taupe) or E4.40.40 (caramel). Alternative colors are available on request
- supplied with glides and felts
- Space between the legs at:
  - table length 180: seat space 126
  - table length 200: seat space 146
  - table length 220: seat space 166
  - table length 240: seat space 186
  - table length 260: seat space 206
  - table length 280: seat space 226
  - table length 300: seat space 246
- finishing possibilities according to the solid wood samples as presented in a current sample box
- The prices are the same for all finishes; soap, oil, stain-lacquer, transparent lacquer and color lacquer.
- in oak the tabletop is possible in a rustic version; cracks in the tabletop and open knots are filled with black coloured filler. This option does not affect the price.
- From 260 Brugt full length (walnut) is composed of several lengths
- combines well with the Marjelle sofa

# DIRK JISK table ONE LEG | RECTANGULAR, SQUARE

design: Gjalt Pilat, 2009

prices 2023 in euro excl. VAT

custom sizes on request

## dimensions

## L x W x H

## light elm

## oak

## walnut

## key features / additional prices

Dirk Jisk table table  
rectangular, frame for  
200/220 cm

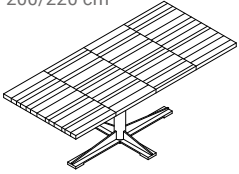

200 x 90 x 76  
200 x 100 x 76  
220 x 90 x 76  
220 x 100 x 76

3.076  
3.195  
3.145  
3.270

3.322  
3.450  
3.397  
3.531

3.654  
3.795  
3.736  
3.884

- thickness of table top is 4 cm
- frame and table top dismountable
- Dirk Jisk table tops (on a single leg) come standard with two sizes of frames, depending on the length of the table
- Frame with coating in the standard colors RAL 9004 (black), RAL 9010 (white), Sikkens C4.40.30 (red), F6.05.50 (taupe) or E4.40.40 (caramel). Alternative colors are available on request
- each table top is divided in 4 equal parts in the longitudinal direction
- The finishing options are according to the solid wood samples such as presented in the current sample box.
- The prices are the same for all finishes; soap, oil, stain-lacquer, transparant lacquer and color lacquer.
- maximum length is 260 cm

Dirk Jisk table rectangular  
frame for 240/260 cm

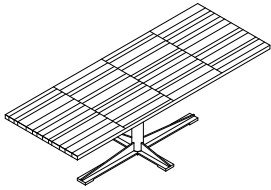

240 x 90 x 76  
240 x 100 x 76  
260 x 90 x 76  
260 x 100 x 76

3.212  
3.346  
3.285  
3.431

3.469  
3.614  
3.548  
3.706

3.816  
3.975  
3.903  
4.076

Dirk Jisk square

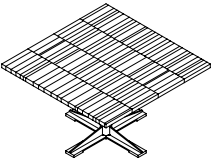

130 x 130 x 76  
140 x 140 x 76  
150 x 150 x 76

3.065  
3.205  
3.345

3.310  
3.461  
3.613

3.641  
3.808  
3.974

- **option for table top**  
tabletop composed of full lengths and varying widths as shown below. Up to 260 cm the price is equal to standard version of the Dirk Jisk table.

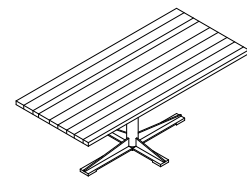

# DIRK JISK table ONE LEG | OVAL, ROUND

design: Gjalt Pilat, 2009

prices 2023 in euro excl. VAT

custom sizes on request

## dimensions

## L x W x H

## light elm

## oak

## walnut

## key features / additional prices

Dirk Jisk table oval  
frame for 200/220 cm



3.263

3.524

3.876

- thickness of table top is 4 cm

3.398

3.670

4.037

- frame and table top dismountable

- Dirk Jisk table tops (on a single leg) come standard with two sizes of frames, depending on the length of the table

- Frame with coating in the standard colors RAL 9004 (black), RAL 9010 (white), Sikkens C4.40.30 (red), F6.05.50 (taupe) or E4.40.40 (caramel). Alternative colors are available on request

Dirk Jisk table oval  
frame for 240/260 cm

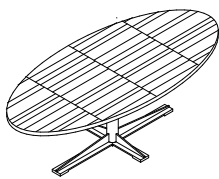

3.552

3.837

4.220

- each table top is divided in 4 equal parts in the longitudinal direction

- The finishing options are according to the solid wood samples such as presented in the current sample box.

- The prices are the same for all finishes; soap, oil, stain-lacquer, transparent lacquer and color lacquer.

- maximum length is 300 cm

### • option for table top

tabletop composed of full lengths and varying widths as shown below.

Up to 260 cm the price is equal to standard version of the Dirk Jisk table.

- Prices indicated with \* Walnut 280 and 300 are not possible in full lengths.

Dirk Jisk table oval  
frame for 280/300 cm

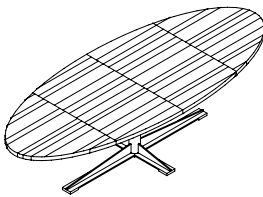

4.021

4.342

\* 4.777

4.551

4.915

\* 5.407

Dirk Jisk round  
Ø 130 x 76  
Ø 145 x 76  
Ø 160 x 76



3.195

3.450

3.795

3.341

3.608

3.969

3.506

3.786

4.165

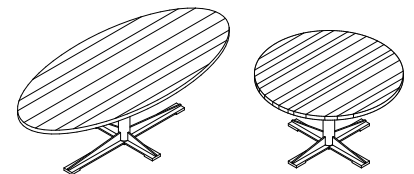

- table top rejuvenation possible, 2 options: facet or rounding, please indicate when ordering. Additional price 5%



# DIRK JISK table DOUBLE SUPPORT | RECTANGULAR

design: Gjalt Pilat, 2020

prices 2023 in euro excl. VAT

custom sizes on request

## dimensions

L x W x H

light elm

oak

walnut

## key features / additional prices

Dirk Jisk table rectangular  
double support

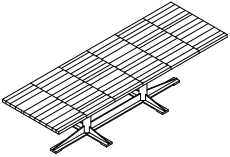

300 x 100 x 76

4.763

5.144

5.530

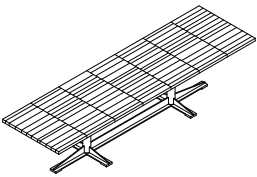

350 x 100 x 76

5.186

5.601

6.021

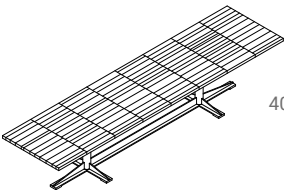

400 x 100 x 76

5.598

6.046

6.499

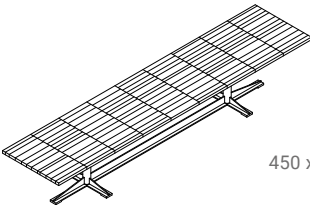

450 x 100 x 76

5.966

6.443

6.926

- thickness of table top is 4 cm
- the table top consists of parts of 50 cm
- extra options table top composition:  
with extra wide parts, extra charge 10%
- Tabel top compositions based on whole lengths are not possible
- Frame and table top are supplied separately
- each length has a unique frame size as shown below
- Frame with coating in the standard colors RAL 9004 (black), RAL 9010 (white), Sikkens C4.40.30 (red), F6.05.50 (taupe) or E4.40.40 (caramel). Alternative colors are available on request
- The finishing options are according to the solid wood samples such as presented in the current sample box.
- The prices are the same for all finishes; soap, oil, stain-lacquer, transparant lacquer and color lacquer.

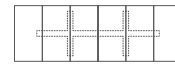

# DIRK JISK table DOUBLE SUPPORT | OVAL WITH STRAIGHT SIDES

design: Gjalt Pilat, 2020

prices 2023 in euro excl. VAT

custom sizes on request

## dimensions

L x W x H

light elm

oak

walnut

## key features / additional prices

Dirk Jisk table oval with straight sides  
double support

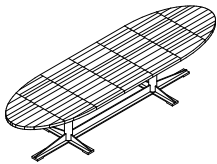

350 x 100 x 76

5.541

5.985

6.433

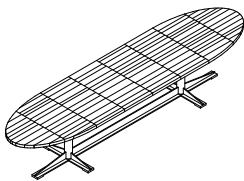

400 x 100 x 76

5.974

6.452

6.936

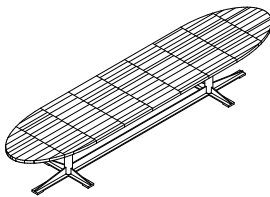

450 x 100 x 76

6.408

6.920

7.439

- thickness of table top is 4 cm
- the table top consists of parts of 50 cm
- extra options table top composition: with extra wide parts, extra charge 10%
- Table top compositions based on whole lengths are not possible
- Frame and table top are supplied separately
- each length has a unique frame size as shown below
- Frame with coating in the standard colors RAL 9004 (black), RAL 9010 (white), Sikkens C4.40.30 (red), F6.05.50 (taupe) or E4.40.40 (caramel). Alternative colors are available on request
- The finishing options are according to the solid wood samples such as presented in the current sample box.
- The prices are the same for all finishes; soap, oil, stain-lacquer, transparent lacquer and color lacquer.
- option for table top table top rejuvenation possible, 2 options: facet or rounding, please indicate when ordering. Additional price 5%

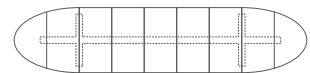
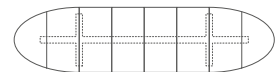
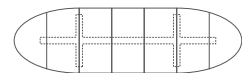
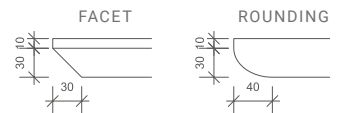

# DJURRE table

design: Gjalt Pilat, 2023

prices 2023 in euro excl. VAT

custom sizes on request

## dimensions

## L x W x H

Djurre rectangular

220 x 100 x 76  
240 x 100 x 76  
260 x 100 x 76  
280 x 100 x 76  
300 x 100 x 76

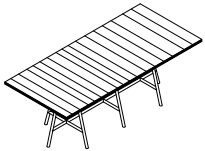

Djurre straight oval

220 x 100 x 76  
240 x 100 x 76  
260 x 110 x 76  
280 x 110 x 76  
300 x 110 x 76  
320 x 110 x 76  
340 x 110 x 76



Djurre oval  
full lengths

220 x 100 x 76  
240 x 110 x 76  
260 x 110 x 76  
280 x 110 x 76  
300 x 120 x 76  
320 x 120 x 76  
340 x 120 x 76

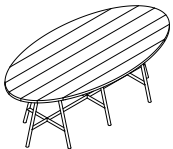

Djurre oval  
several lengths

220 x 100 x 76  
240 x 110 x 76  
260 x 110 x 76  
280 x 110 x 76  
300 x 120 x 76  
320 x 120 x 76  
340 x 120 x 76

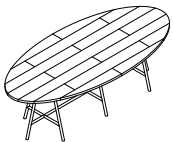

## beech

## light elm

## oak

## walnut

3.612  
3.723  
3.841  
4.188  
4.347

3.901  
4.021  
4.148  
4.523  
4.695

4.194  
4.323  
4.460  
4.862  
5.047

3.599  
3.685  
4.004  
4.416  
4.697  
5.040  
5.256

3.887  
3.979  
4.325  
4.769  
5.073  
5.443  
5.676

4.178  
4.278  
4.649  
5.127  
5.453  
5.852  
6.102

3.446  
3.592  
3.751  
4.139  
4.416  
\* 4.718  
\* 4.881

3.721  
3.879  
4.051

4.001  
4.170

4.718  
4.881

4.471  
4.769  
5.095  
5.272

4.355  
4.806  
5.127  
5.477  
5.667

## key features / additional prices

- table top thickness 3 cm
- 3 table top shapes possible: 1. rectangular with profiled edges <sup>A</sup>) + composition from whole lengths, transverse to the direction of the table 2. straight-oval with rounded sides composed of several lengths <sup>B</sup>) and 3. oval with full lengths table top composition <sup>C</sup>)
- \* Djurre oval: table top composition, light elm from length 320 with several lengths. Beech is possible with whole lengths up to and including 340 cm
- the frame is constructed from steel pipes with a diameter of 3 cm
- base with coating in the standard colors RAL 9004 (black), RAL 9010 (white), Sikken C4.40.30 (red), F6.05.50 (taupe) or E4.40.40 (caramel). Alternative colors are possible on request
- The finishing options are according to the solid wood samples such as presented in the current sample box.
- The prices are the same for all finishes; soap, oil, stain-lacquer, transparent lacquer and color lacquer.

• <sup>A</sup>) side view rectangular table top:

3 cm thick table top with profiled edges:

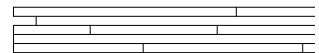

• <sup>B</sup>) side view rounding straight-oval:



• <sup>C</sup>) side view oval:

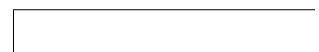

# DORUS table

design: Gjalt Pilat, 1998

prices 2023 in euro excl. VAT

*custom sizes on request*

## dimensions

## L x W x H

## light elm

## oak

## walnut

## key features / additional prices

Dorus table width 90 cm

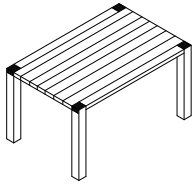

140 x 90 x 76

2.151

2.323

2.672

- thickness of table top 4 cm

160 x 90 x 76

2.349

2.537

2.917

- the leg of a Dorus table is 8,8 x 8,8 cm

180 x 90 x 76

2.469

2.667

3.067

- the legs of a Dorus table are not dismountable

200 x 90 x 76

2.577

2.783

3.200

- the table top is assembled of variable widths

220 x 90 x 76

2.878

3.109

3.575

- also see: Dorus bench

240 x 90 x 76

3.295

3.559

4.093

- The finishing options are according to

Dorus table width

140 x 100 x 76

2.218

2.396

2.755

- the solid wood samples such as

100 cm

160 x 100 x 76

2.457

2.654

3.052

- presented in the current sample box.

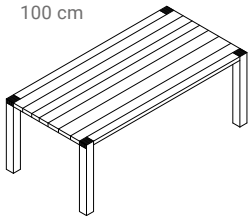

180 x 100 x 76

2.577

2.783

3.200

- The prices are the same for all finishes;

200 x 100 x 76

2.682

2.896

3.331

- soap, oil, stain-lacquer, transparent lacquer and color lacquer.

220 x 100 x 76

3.025

3.267

3.758

- in oak the tabletop is possible in a rustic

240 x 100 x 76

3.446

3.721

4.280

- version; cracks in the tabletop and open

- knots are filled with black coloured filler.

- This option does not affect the price.



# ELIZABETH II table

design: Gjalt Pilat, 2016

prices 2023 in euro excl. VAT

*custom sizes on request*

## dimensions

## L x W x H

Elizabeth II table: 3 legs	160 x 100 x 76
	180 x 100 x 76
	200 x 100 x 76
	220 x 100 x 76

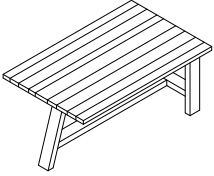

Elizabeth II table: 4 legs	240 x 100 x 76
	260 x 100 x 76
	280 x 100 x 76
	300 x 100 x 76
	320 x 100 x 76
	340 x 100 x 76
	360 x 100 x 76



## light elm

## oak

## walnut

## key features / additional prices

2.609	2.817	3.240
2.689	2.904	3.339
2.769	2.991	3.439
2.849	3.077	3.539
3.399	3.671	4.222
3.479	3.758	4.321
3.558	3.843	4.419
3.640	3.931	4.521
3.719	4.017	4.619
3.799	4.103	4.718
3.879	4.189	4.818

- thickness of table top 4 cm
- also see Elizabeth II bench
- the legs measure 6 x 12 cm
- frame/table top dismountable
- from 240 cm on 4 legs
- the table top is made of variable widths and up to 220 cm of full lengths. Longer table tops are built up of 2 or 3 lengths
- The finishing options are according to the solid wood samples such as presented in the current sample box.
- The prices are the same for all finishes; soap, oil, stain-lacquer, transparent lacquer and color lacquer.
- in oak the tabletop is possible in a rustic version; cracks in the tabletop and open knots are filled with black coloured filler. This option does not affect the price.

# HINDRIK LANGSHOUT table

design: Gjalt Pilat, 2004

prices 2023 in euro excl. VAT

custom sizes on request

## dimensions

## L x W x H

## light elm

## oak

## walnut

## key features / additional prices

Hindrik Langshout table

160 x 81 x 76  
180 x 81 x 76  
200 x 81 x 76  
220 x 81 x 76  
240 x 81 x 76

2.379  
2.579  
2.778  
2.975  
3.173

2.569  
2.785  
3.000  
3.213  
3.427

2.955  
3.203  
3.450  
3.695  
3.941

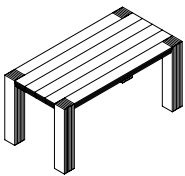

160 x 94,5 x 76  
180 x 94,5 x 76  
200 x 94,5 x 76  
220 x 94,5 x 76  
240 x 94,5 x 76

2.620  
2.839  
3.056  
3.272  
3.490

2.829  
3.066  
3.300  
3.534  
3.770

3.254  
3.526  
3.795  
4.064  
4.335

Hindrik Langshout table  
with table top composition  
from 260 cm

260 x 81 x 76  
280 x 81 x 76  
300 x 81 x 76  
260 x 94,5 x 76  
280 x 94,5 x 76  
300 x 94,5 x 76

3.372  
3.571  
3.771  
3.710  
3.928  
4.147

3.642  
3.857  
4.072  
4.006  
4.242  
4.479

4.188  
4.435  
4.683  
4.607  
4.878  
5.151

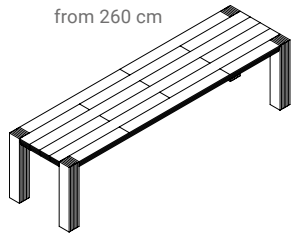

Hindrik Langshout  
standard demountable  
legs, at no extra charge  
from 320 cm

320 x 81 x 76  
340 x 81 x 76  
360 x 81 x 76  
380 x 81 x 76  
400 x 81 x 76

4.451  
4.650  
4.849  
5.048  
5.248

4.807  
5.022  
5.237  
5.452  
5.668

5.529  
5.775  
6.023  
6.269  
6.518

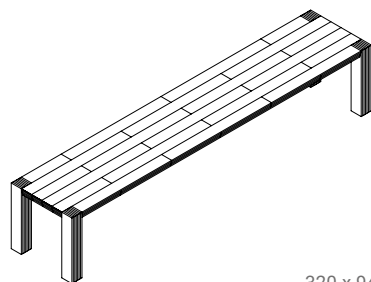

320 x 94,5 x 76  
340 x 94,5 x 76  
360 x 94,5 x 76  
380 x 94,5 x 76  
400 x 94,5 x 76

4.897  
5.114  
5.333  
5.553  
5.772

5.288  
5.523  
5.760  
5.998  
6.233

6.082  
6.352  
6.624  
6.897  
7.168

- the tabletop of the Hindrik Langshout consists of widths of 13.5 cm
- the legs measure 13,5 x 13,5 cm
- thickness of the table top is 8 cm
- from 260 cm the table top is made up of 2 or 3 lengths as shown on the left
- From 320 cm in length, the table is equipped with demountable legs as standard. The extra price for removable legs is included in the price. From 320 cm the table top is 2 cm in the center and 8 cm thick on the sides
- extra price for demountable legs for lengths up to 320 cm is 293,- euro
- with the first supplied Hindrik Langshout with removable legs, standard two trestles are included as mounting aid, ask for these with your order
- also see: Hindrik Langshout bench
- The finishing options are according to
- the solid wood samples such as
- presented in the current sample box.
- The prices are the same for all finishes; soap, oil, stain-lacquer, transparent lacquer and color lacquer.

# JEHANNES table

design: Gjalt Pilat, 2007

prices 2023 in euro excl. VAT

*custom sizes on request*

## dimensions

## L x W x H

## light elm

## oak

## walnut

## key features / additional prices

Jehannes table

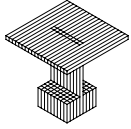

60 x 60 x 76

1.380

1.490

1.713

- thickness of table top 4 cm

64 x 64 x 76

1.418

1.532

1.761

- The finishing options are according to

76 x 76 x 76

1.490

1.610

1.851

- the solid wood samples such as presented in the current sample box.

Jehannes bar table

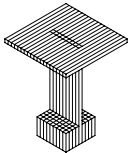

60 x 60 x 104

1.470

1.587

1.825

- The prices are the same for all finishes;

76 x 76 x 104

1.578

1.704

1.960

- soap, oil, stain-lacquer, transparant lacquer and color lacquer.

Jehannes standing table

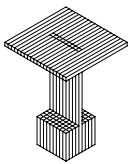

60 x 60 x 110

1.470

1.587

1.825

76 x 76 x 110

1.578

1.704

1.960

# JELLE table

design: Gjal't Pilat, 1997

prices 2023 in euro excl. VAT

*custom sizes on request*

## dimensions

## L x W x H

## light elm

## oak

## walnut

## key features / additional prices

Jelle table

250 x 117 x 76

2.903

3.136

3.606

space

between legs:

135 / 63 cm

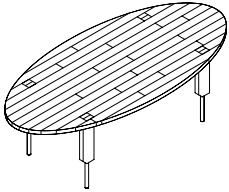

300 x 120 x 76

3.205

3.461

3.981

space

between legs:

183 / 54 cm

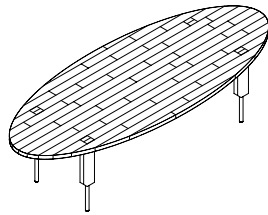

- thickness of table top 4 cm
- standard with legs that go through the table top and are connected to the tabletop as a whole
- optionally with removable legs, attached to the downside of the table top. The table top is then without the end-grain detail where the legs are positioned.
- a Jelle table with removable legs has the same price as a Jelle with fixed mounted legs
- composition of the table top of variable lengths and widths with a fixed size of 90 cm
- standard the lower part of the table leg is stainless steel
- for the lower part of the leg in RAL 9004 (black) coating a discount of 83, - euro on the table applies
- The finishing options are according to the solid wood samples such as presented in the current sample box.
- The prices are the same for all finishes; soap, oil, stain-lacquer, transparent lacquer and color lacquer.

# JONAS II table

design: Gjalt Pilat, 2015

prices 2023 in euro excl. VAT

custom sizes on request

## dimensions

## L x W x H

## light elm

## oak

## walnut

## key features / additional prices

Jonas Light table

200 x 103 x 76

3.006

3.246

3.733

- the Jonas II has legs measuring 14 x 14 cm and a tabletop thickness of 3 cm

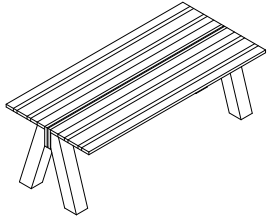

220 x 103 x 76

3.161

3.414

3.926

- with an Arpa Fenix finish, the line under the table top remains solid wood

240 x 103 x 76

3.319

3.585

4.123

- for Fenix top layers the following standard colors apply:

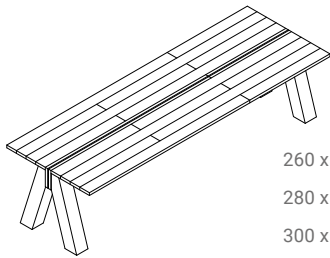

260 x 103 x 76

3.488

3.767

4.332

0029 Bianco Malé

280 x 103 x 76

3.665

3.958

4.552

0720 Nero Ingo

300 x 103 x 76

3.838

4.145

4.766

0717 Castoro Ottawa

- Jonas table is dismountable in two parts

- Jonas legs are hollow

- from 260 cm the tabletop is composed of 2 lengths

- The finishing options are according to the solid wood samples such as presented in the current sample box.

- The prices are the same for all finishes; soap, oil, stain-lacquer, transparent lacquer and color lacquer.

Jonas Light table

200 x 103 x 76

3.306

3.570

4.106

Fenix table top

220 x 103 x 76

3.478

3.756

4.319

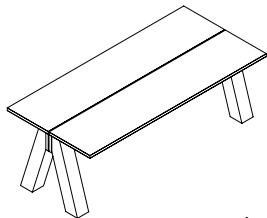

240 x 103 x 76

3.652

3.944

4.536

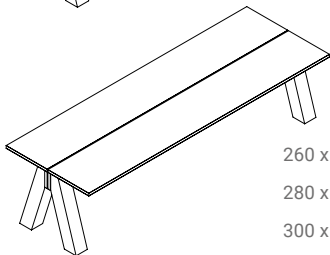

260 x 103 x 76

3.837

4.144

4.765

280 x 103 x 76

4.031

4.354

5.007

300 x 103 x 76

4.222

4.560

5.244

# KLAAS table

design: Trude van Assem, 2008

prices 2023 in euro excl. VAT

custom sizes on request

## dimensions

Klaas table

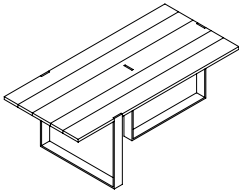

## L x W x H

180 x 92 x 76
200 x 92 x 76
220 X 92 X 76
240 x 92 x 76
260 x 92 x 76

## beech

### light elm

### oak

### walnut

2.842
2.933
3.052
3.169
3.271

3.070
3.168
3.296
3.423
3.533

3.377
3.485
3.626
3.765
3.886

## key features / additional prices

- thickness of tabletop is 3 cm
- tabletop is composed of full lengths and variable widths
- frame is made of steel size 10 x 1,2 cm
- frame parts and tabletop are dismountable
- in oak the tabletop is possible in a rustic version; cracks in the tabletop and open knots are filled with black coloured filler. This option does not affect the price.
- Frame with coating in the standard colors RAL 9004 (black), RAL 9010 (white), Sikkens C4.40.30 (red), F6.05.50 (taupe) or E4.40.40 (caramel). Alternative colors are available on request
- overhang tabletop of the transversely placed frame part:
  - table length 180 cm : 39 cm
  - table length 200 cm: 51 cm
  - table length 220-260 cm: 60 cm
- also see: Klaas coffeetable
- The finishing options are according to the solid wood samples such as presented in the current sample box.
- The prices are the same for all finishes; soap, oil, stain-lacquer, transparant lacquer and color lacquer.

- Dimensions of gaps at length from 180 cm (in mm's):

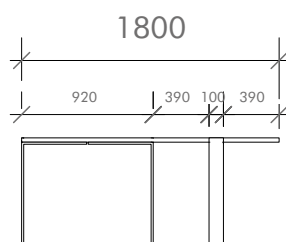

# KODAMA table series

design: Bart Vos, 2022

prices 2023 in euro excl. VAT

*no customization possible*

## dimensions

L x W x H

**beech**

**light elm**

**oak**

**walnut**

## key features / additional prices

Kodama 1

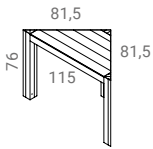

115 x 57,5 x 76

1.110

1.198

1.318

Kodama 2

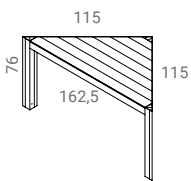

162,5 x 81,5 x 76

1.507

1.627

1.790

Kodama 3

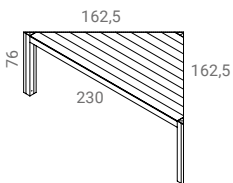

230 x 115 x 76

2.002

2.162

2.378

Kodama 4

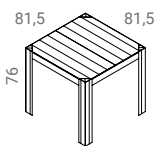

81,5 x 81,5 x 76

1.239

1.339

1.472

Kodama 5

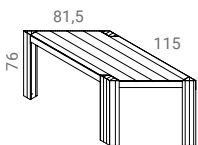

172,5 x 57,5 x 76

1.735

1.874

2.062

Klem



prijs per stuk

45

45

45

- thickness of table top is 4 cm
- dismountable legs; table top and legs are supplied separately
- legs are adjustable
- note: the parallelogram cannot be executed in mirror image
- Due to the dimensions, a combination of tables is possible
- tables can be linked with optional clamps
- required number of clamps on a length of:
 

81.5 cm	1 clamp
115 cm	1 clamp
162.5 cm	2 clamps
260 cm	2 clamps
- possible in oak, light elm and walnut
- The finishing options are according to the solid wood samples such as presented in the current sample box.
- The prices are the same for all finishes; soap, oil, stain-lacquer, transparant lacquer and color lacquer.

# KODAMA table series

COMBINATION EXAMPLES

design: Bart Vos, 2022

prices 2023 in euro excl. VAT

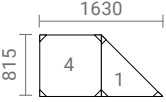
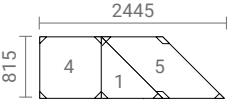
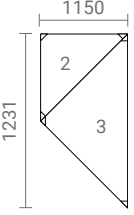
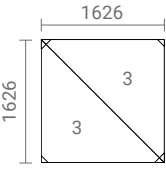
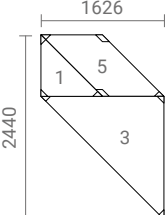
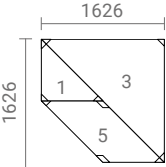
Price examples	Components	wood			amount	total
		beech light elm	oak	walnut		
<b>Setup 1</b>						
	kodama 4		1.339		1	1.339
	kodama 1		1.198		1	1.198
						<b>2.537</b> oak
<b>Setup 2</b>						
	kodama 4	1.239			1	1.239
	kodama 1	1.110			1	1.110
	kodama 5	1.735			1	1.735
						<b>4.084</b> light elm
<b>Setup 3</b>						
	kodama 2			1.790	1	1.790
	kodama 3			2.378	1	2.378
						<b>4.168</b> walnut
<b>Setup 4</b>						
	kodama 3	2.002			2	<b>4.004</b> beech
<b>Setup 5a</b>						
	kodama 1		1.198		1	1.198
	kodama 5		1.874		1	1.874
	kodama 3		2.162		1	2.162
						<b>5.234</b> oak
<b>Setup 5b</b>						
	Same set as 5a different Setup					



# KODAMA table series COMBINATION EXAMPLES

design: Bart Vos, 2022

prices 2023 in euro excl. VAT

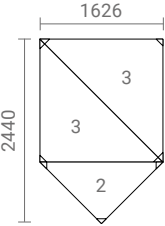
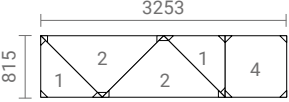
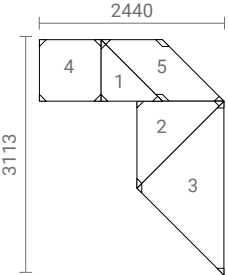
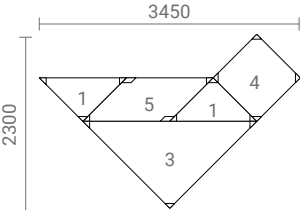
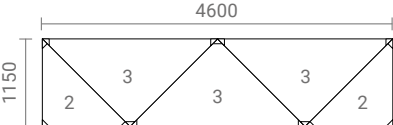
Price examples	Components				amount	total
		beech light elm	oak	walnut		
<b>Setup 6</b>						
	kodama 3			2.378	2	4.756
	kodama 2			1.790	1	1.790
						<b>6.546</b> walnut
<b>Setup 7</b>						
	kodama 1		1.198		2	2.396
	kodama 2		1.627		2	3.254
	kodama 4		1.339		1	1.339
						<b>6.989</b> oak
<b>Setup 8</b>						
	kodama 4	1.239			1	1.239
	kodama 1	1.110			1	1.110
	kodama 5	1.735			1	1.735
	kodama 2	1.507			1	1.507
	kodama 3	2.002			1	2.002
						<b>7.593</b> beech
<b>Setup 9</b>						
	kodama 1		1.198		2	2.396
	kodama 5		1.874		1	1.874
	kodama 4		1.339		1	1.339
	kodama 3		2.162		1	2.162
						<b>7.771</b> oak
<b>Setup 10</b>						
	kodama 3	2.002			3	6.006
	kodama 2	1.507			2	3.014
						<b>9.020</b> light elm

# MADS table

design: Gjalt Pilat, 2014

prices 2023 in euro excl. VAT

custom sizes on request

## dimensions

## L x W x H

Mads table	300 x 90 x 76
table top composition	350 x 90 x 76
full lengths in oak	400 x 90 x 76
	450 x 90 x 76
	500 x 90 x 76

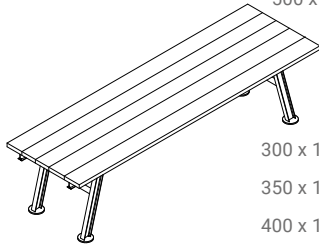

300 x 100 x 76
350 x 100 x 76
400 x 100 x 76
450 x 100 x 76
500 x 100 x 76

Mads table top composition	300 x 90 x 76
light elm, oak or walnut	350 x 90 x 76
	400 x 90 x 76
	450 x 90 x 76
	500 x 90 x 76

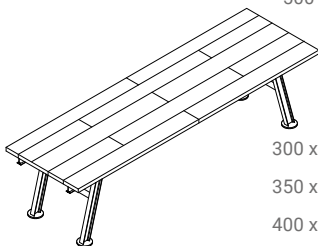

300 x 100 x 76
350 x 100 x 76
400 x 100 x 76
450 x 100 x 76
500 x 100 x 76

## oak

3.850
4.231
4.613
4.995
5.377

## light elm

3.386
3.721
4.057
4.393
4.730

## oak

3.656
4.018
4.381
4.744
5.108

## walnut

4.022
4.420
4.820
5.219
5.619

3.723
4.093
4.463
4.832
5.203

4.021
4.420
4.820
5.219
5.619

4.423
4.862
5.302
5.741
6.181

## key features / additional prices

- see also: Mads bench
- Frame with coating in the standard colors RAL 9004 (black), RAL 9010 (white), Sikkens C4.40.30 (red), F6.05.50 (taupe) or E4.40.40 (caramel). Alternative colors are available on request
- in oak the tabletop consists of 4 or 5 parts with a total width of 90 or 100 cm and full lengths. Ask for the stock and customization options.
- by using wide parts of wood, the delivery time of this table can be longer than usual
- both pictures show a Mads table with an oak table top
- a light elm or walnut table top can be composed as seen on the second picture
- overhang at:
  - length 300 cm: 37 cm
  - length 350 cm: 47 cm
  - length 400 cm: 89.5 cm
  - length 450 cm: 97.5 cm
  - length 500 cm: 100 cm
- The finishing options are according to the solid wood samples such as presented in the current sample box.
- The prices are the same for all finishes; soap, oil, stain-lacquer, transparent lacquer and color lacquer.
- in oak the tabletop is possible in a rustic version; cracks in the tabletop and open knots are filled with black coloured filler. This option does not affect the price.

# PAKE SYTSE table OVAL

design: Gjalt Pilat, 2010

prices 2023 in euro excl. VAT

custom sizes on request

dimensions	L x W x H
Pake Sytse table oval	250 x 130 x 76, 8-poots
	300 x 130 x 76, 10-poots
	350 x 130 x 76, 12-poots
	400 x 130 x 76, 14-poots
	450 x 130 x 76, 16 poots
	500 x 130 x 76, 16-poots

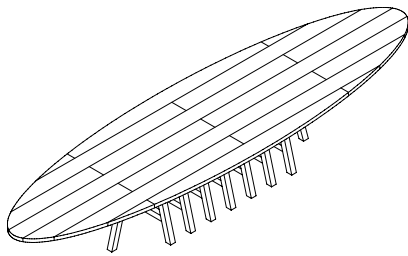

Pake Sytse table round	Ø 160 x 76, 8-poots
	Ø 160 x 104, 8-poots

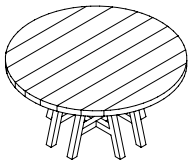

Example option table top edge and frame lacquered in color

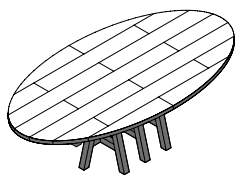

light elm	oak	walnut
5.043	5.446	6.263
5.874	6.344	7.295
6.704	7.240	8.327
7.219	7.796	8.966
7.613	8.223	9.456
8.005	8.646	9.943

4.734	5.113	5.880
4.911	5.304	6.100

## key features / additional prices

- thickness of table top is 4 cm
- round Pake Sytse available in two heights, standard height 76 cm and as a bar table, height 104 cm
- composition of the table top alternately 1 and 2 lengths of wood to a table length of 200 cm
- from 250 cm length the tabletop is composed alternately of 2 and 3 lengths
- because of the use of wide parts of wood, the delivery time of this table can be longer than usual
- The finishing options are according to the solid wood samples such as
- presented in the current sample box.
- The prices are the same for all finishes; soap, oil, stain-lacquer, transparent lacquer and color lacquer.
- in oak the tabletop is possible in a rustic version; cracks in the tabletop and open knots are filled with black coloured filler. This option does not affect the price.
- option table top edge and base in colored lacquer, no extra charge. See example

## OVERVIEW TABLE TOP COMPOSITION:

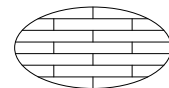

Pake Sytse oval 250 x 130 cm

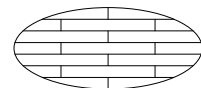

Pake Sytse oval 300 x 130 cm



Pake Sytse oval 400 x 130 cm

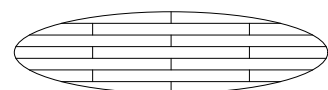

Pake Sytse oval 500 x 130 cm

# PAKE SYTSE table RECTANGULAR

design: Gjalt Pilat, 2010

prices 2023 in euro excl. VAT

custom sizes on request

dimensions	L x W x H
Pake Sytse table rectangular	200 x 100 x 76, 6-poots
	250 x 110 x 76, 8-poots
	300 x 110 x 76, 10-poots
	350 x 110 x 76, 12-poots
	400 x 110 x 76, 14-poots
	450 x 110 x 76, 16-poots

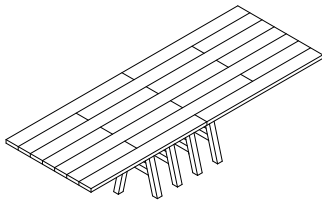

Example option table top edge and frame lacquered in color

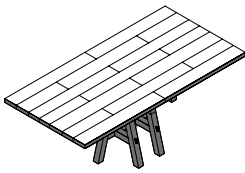

	light elm	oak	walnut
	3.307	3.572	4.108
	4.093	4.420	5.083
	4.878	5.268	6.058
	5.665	6.118	7.036
	6.450	6.966	8.011
	7.236	7.815	8.987

## key features / additional prices

- thickness of table top is 4 cm
- composition table top alternately 1 and 2 lengths of wood to a table length of 200 cm
- from 250 cm length the tabletop is composed alternately of 2 and 3 lengths
- because of the use of wide parts of wood, the delivery time of this table can be longer than usual
- The finishing options are according to the solid wood samples such as presented in the current sample box.
- The prices are the same for all finishes; soap, oil, stain-lacquer, transparant lacquer and color lacquer.
- in oak the tabletop is possible in a rustic version; cracks in the tabletop and open knots are filled with black coloured filler. This option does not affect the price.
- option table top edge and base in colored lacquer, no extra charge. See example

## OVERVIEW TABLE TOP COMPOSITION:

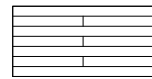

Pake Sytse 200 x 100 cm

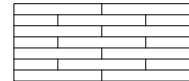

Pake Sytse 250 x 110 cm



Pake Sytse 300 x 110 cm

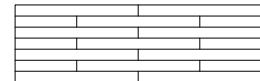

Pake Sytse 350 x 110 cm

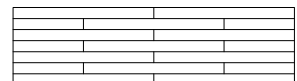

Pake Sytse 400 x 110 cm

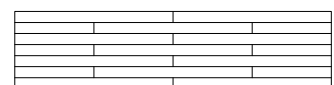

Pake Sytse 450 x 110 cm

# STIEN table

design: Gjalt Pilat 2021

prices 2023 in euro excl. VAT

custom sizes on request

## dimensions

## L x W x H

## light elm

## oak

## walnut

## key features / additional prices

### Stien table rectangular

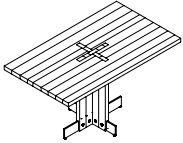

140x80x76	2.283	2.465	2.835
160x80x76	2.395	2.587	2.975
180x80x76	2.638	2.849	3.276
200x90x76	2.746	2.966	3.411
220x90x76	2.854	3.082	3.544

### Stien table rechthoekig

#### 2-legs

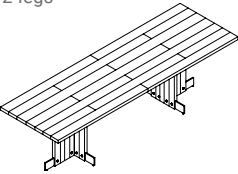

240x90x76	3.300	3.565	4.099
260x90x76	3.384	3.655	4.203
280x90x76	3.713	4.010	4.612
300x90x76	4.086	4.413	5.075
350x100x76	4.433	4.788	5.506
400x100x76	5.074	5.480	6.301

### Stien table oval

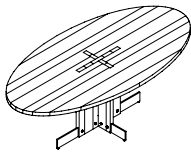

180x110x76	2.871	3.100	3.565
200x110x76	3.050	3.294	3.789
220x110x76	3.266	3.527	4.057

### Stien table round

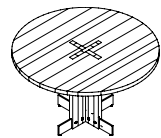

Ø 130x76	2.891	3.123	3.591
Ø 140x76	3.031	3.274	3.765
Ø 150x76	3.184	3.439	3.955
Ø 160x76	3.312	3.577	4.113

- thickness of tabletop is 4 cm
- frame parts and tabletop delivered disassembled
- 2-legged tables: top in 2 to 3 lengths, without wood insert in the top of the sheet
- Space between the legs at 2-legged + recommended number of chairs:  
length 240: seat space 76 cm, 6 seats  
length 260: seat space 82 cm, 6 seats  
length 280: seat space 136 cm, 8 seats  
length 300: seat space 146 cm, 8 seats
- frame with coating in the standard colors RAL 9004 (black), RAL 9010 (white), Sikkens C4.40.30 (red), F6.05.50 (taupe) or E4.40.40 (caramel). Alternative colors are available on request
- frame with adjustable feet
- The finishing options are according to the solid wood samples such as presented in the current sample box.
- The prices are the same for all finishes; soap, oil, stain-lacquer, transparent lacquer and color lacquer.

# TIEMEN I table

design: Gjalt Pilat, 2009

prices 2023 in euro excl. VAT

*custom sizes on request*

## dimensions

Tiemen I table

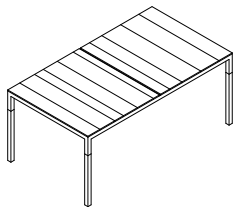

## L x W x H

140 x 90 x 76
160 x 90 x 76
180 x 90 x 76
200 x 90 x 76
220 x 90 x 76
240 x 90 x 76
140 x 100 x 76
160 x 100 x 76
180 x 100 x 76
200 x 100 x 76
220 x 100 x 76
240 x 100 x 76

## beech

### light elm

### oak

### walnut

1.531	1.653	1.819
1.594	1.721	1.893
1.658	1.791	1.970
1.722	1.860	2.046
1.808	1.952	2.147
1.849	1.997	2.196
1.636	1.767	1.944
1.709	1.845	2.030
1.779	1.922	2.114
1.851	1.999	2.198
1.920	2.074	2.281
1.991	2.151	2.366

## key features / additional prices

- tabletop thickness 2 cm, of which 1 cm is visible
- legs and frame 4 x 4 cm
- the lower part of the leg consists of a length of 55 cm solid wood
- with a Tiemen longer than 220 the leg gets a wooden part of 20 cm
- option: legs entirely of steel is also possible without additional cost
- composition from whole lengths of wood, transverse to the direction of the table
- the seam of 1.5 cm in the middle of the tabletop is required, due to the working of the wood
- frame with coating in the standard colors RAL 9004 (black), RAL 9010 (white), Sikkens C4.40.30 (red), F6.05.50 (taupe) or E4.40.40 (caramel). Alternative colors are available on request
- also see: Tiemen coffeetable
- The finishing options are according to the solid wood samples such as presented in the current sample box.
- The prices are the same for all finishes; soap, oil, stain-lacquer, transparent lacquer and color lacquer.

# TIEMEN II table

design: Gjalt Pilat, 2009

prices 2023 in euro excl. VAT

*custom sizes on request*

## dimensions

Tiemen II table

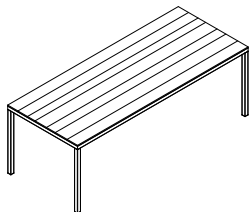

## L x W x H

140 x 90 x 76
160 x 90 x 76
180 x 90 x 76
200 x 90 x 76
220 x 90 x 76
240 x 90 x 76
140 x 100 x 76
160 x 100 x 76
180 x 100 x 76
200 x 100 x 76
220 x 100 x 76
240 x 100 x 76

## beech

### light elm

### oak

### walnut

1.531	1.653	1.819
1.594	1.721	1.893
1.658	1.791	1.970
1.722	1.860	2.046
1.808	1.952	2.147
1.849	1.997	2.196
1.636	1.767	1.944
1.709	1.845	2.030
1.779	1.922	2.114
1.851	1.999	2.198
1.920	2.074	2.281
1.991	2.151	2.366

## key features / additional prices

- tabletop thickness 3 cm, of which 1 cm is visible
- legs and frame 4 x 4 cm
- legs entirely of steel
- composition from whole lengths of wood, in the longitudinal direction of the table
- frame with coating in the standard colors RAL 9004 (black), RAL 9010 (white), Sikkens C4.40.30 (red), F6.05.50 (taupe) or E4.40.40 (caramel). Alternative colors are available on request
- also see: Tiemen I and Tiemen coffeetable
- The finishing options are according to the solid wood samples such as presented in the current sample box.
- The prices are the same for all finishes; soap, oil, stain-lacquer, transparant lacquer and color lacquer.

# TOM table

design: Chris Slutter, 2018

prices 2023 in euro excl. VAT

*custom sizes on request*

## dimensions

## L x W x H

## light elm

## oak

## walnut

## key features / additional prices

Tom rectangular

220 x 100 x 76

3.119

3.369

3.706

- tabletop thickness is 4 cm

240 x 100 x 76

3.200

3.456

3.802

- comes in 2 parts: frame and tabletop

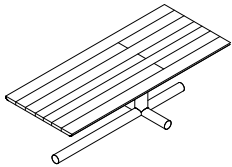

- the largest sizes shown are the maximum possible sizes.

- frame with coating in the standard colors RAL 9004 (black), RAL 9010 (white), Sikkens C4.40.30 (red), F6.05.50 (taupe) or E4.40.40 (caramel). Alternative colors are available on request

Tom oval

220 x 110 x 76

3.204

3.461

3.807

- The finishing options are according to the solid wood samples such as presented in the current sample box.

240 x 110 x 76

3.356

3.625

3.987

- The prices are the same for all finishes; soap, oil, stain-lacquer, transparent lacquer and color lacquer.

260 x 110 x 76

3.512

3.793

4.172

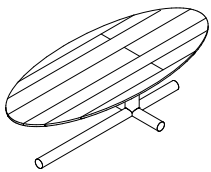



# WYBE table

design: Gjalt Pilat, 2017

prices 2023 in euro excl. VAT

custom sizes on request

## dimensions

## L x W x H

Wybe table	200 x 100 x 76
diamond pattern	220 x 100 x 76
	240 x 100 x 76
	260 x 100 x 76
	280 x 100 x 76
	* 300 x 100 x 76

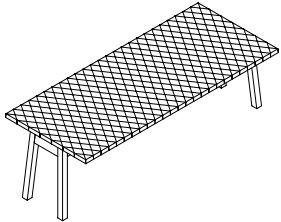

Wybe table full lengths	200 x 100 x 76
	220 x 100 x 76
	240 x 100 x 76
	260 x 100 x 76
	280 x 100 x 76
	* 300 x 100 x 76

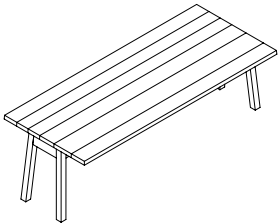

Wybe table	260 x 100 x 76
several lengths	280 x 100 x 76
(walnut)	* 300 x 100 x 76

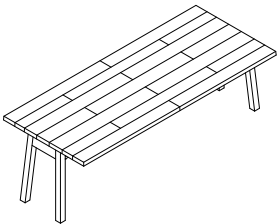

Wybe table round	Ø 130 x 76
full lengths	Ø 140 x 76
	Ø 150 x 76
	Ø 160 x 76

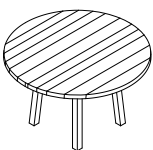

## light elm

2.715
2.829
2.942
3.056
3.171
3.367

## light elm

1.910
1.977
2.046
2.116
2.185
2.357

## oak

2.063
2.135
2.210
2.285
2.360
2.545

## walnut

3.372
3.513
3.654
3.795
3.938
4.181

## walnut

2.372
2.455
2.542

2.628
2.714
2.927

## key features / additional prices

- thickness of tabletop is 4 cm
- the legs measure 6 x 6 cm
- composition of tabletop with diamond pattern or longitudinal wood
- The Wybe in diamond pattern is not possible in oak.
- the Wybe is available with an overhang at the head end, the same as that on the long side: 30 cm. this does not give a price difference.
- the Wybe version full lengths is also available in oak. From 260, walnut (long wood) is composed of several lengths
- The table tops with a length of \* 300 cm are executed with overhang, without overhang a maximum of 280 cm is possible.
- The finishing options are according to the solid wood samples such as presented in the current sample box.
- The prices are the same for all finishes; soap, oil, stain-lacquer, transparent lacquer and color lacquer.

Standard

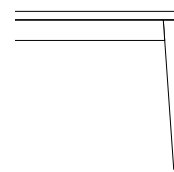

With overhang

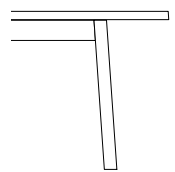

Wybe table with overhang on the head side possible on request

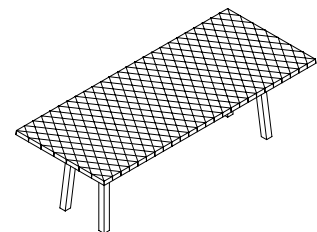

# COFFEE TABLES & SMALL TABLES

prices 2023 in euro excl. VAT

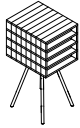

**ANNEBETH**  
page 43

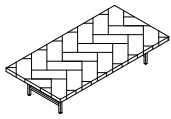

**BRUGT**  
page 34



**EIRIK**  
page 43

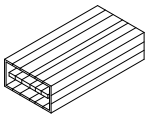

**FREEK**  
page 35

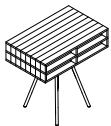

**HILDE HYK**  
page 43

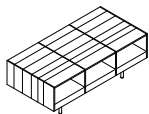

**HOTZE**  
page 36



**HYKE**  
page 43

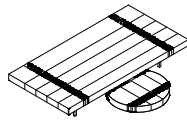

**JACOBA**  
page 37

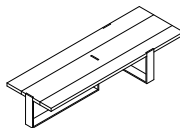

**KLAAS**  
page 38

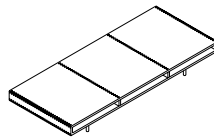

**MEINT**  
page 39

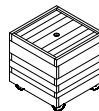

**NEL**  
page 43



**PAKE SYTSE**  
page 44

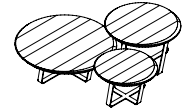

**SILAS**  
page 40



**SYL**  
page 44

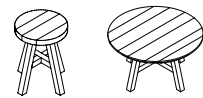

**SYTO**  
page 41

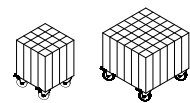

**SIEBREN**  
SMALL/LARGE  
page 44

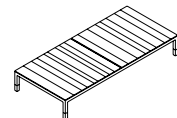

**TIEMEN I**  
page 42

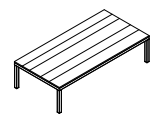

**TIEMEN II**  
page 42

# BRUGT coffee table

design: Gjalt Pilat, 2021

prices 2023 in euro excl. VAT

*custom sizes on request*

## dimensions

## L x W x H

## light elm

## oak

## walnut

## key features / additional prices

**Brugt coffee table**  
(hight 30cm)

80 x 80 x 30  
120 x 120 x 30

1.282  
1.857

1.385  
2.005

1.523  
2.206

- standard table top herringbone pattern

- table top thickness is 3,8 cm

- frame solid steel 2 x 2 cm

- Frame with coating in the standard colors RAL 9004 (black), RAL 9010 (white), Sikkens C4.40.30 (red), F6.05.50 (taupe) or E4.40.40 (caramel). Alternative colors are available on request

- supplied with felt pads and glides

- The finishing options are according to

- the solid wood samples such as

- presented in the current sample box.

- The prices are the same for all finishes;

- soap, oil, stain-lacquer, transparant

- lacquer and color lacquer.

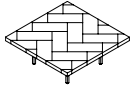

**Brugt coffee table rectangular**  
(hight 30cm)

120 x 60 x 30  
120 x 80 x 30  
140 x 70 x 30  
160 x 80 x 30

1.361  
1.496  
1.528  
1.722

1.469  
1.615  
1.650  
1.859

1.616  
1.777  
1.815  
2.045

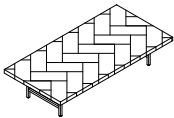

**Brugt table 'low dining'**  
(hight 64cm)

80 x 80 x 64  
120 x 120 x 64

1.321  
1.900

1.427  
2.051

1.569  
2.257

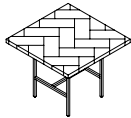

**Brugt table rectangular**  
(hight 64cm)

120 x 60 x 64  
120 x 80 x 64  
140 x 70 x 64  
160 x 80 x 64

1.398  
1.535  
1.573  
1.766

1.509  
1.658  
1.699  
1.908

1.660  
1.824  
1.869  
2.098

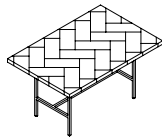

# FREEK coffee table

design: Peter Tromop, 2009

prices 2023 in euro excl. VAT

custom sizes on request

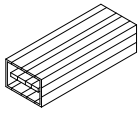
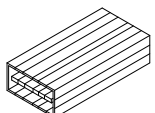
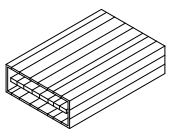
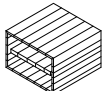
dimensions	L x W x H	light elm	oak	walnut	key features / additional prices	
Freek coffee table 45 cm wide 	80 x 45 x 22	1.068	1.154	1.327	<ul style="list-style-type: none"> <li>• standard colour of the partition board, supporting the shelf F6.03.20 (Grey-Brown)</li> <li>• shelf thickness is 4 cm, wood of the body is 2 cm thick</li> <li>• possible in three heights: 22, 32 cm or 42 cm</li> <li>• coffee table, 22 cm high has no shelf</li> <li>• compartment inside is 34 cm deep</li> <li>• The finishing options are according to the solid wood samples such as presented in the current sample box.</li> <li>• The prices are the same for all finishes; soap, oil, stain-lacquer, transparent lacquer and color lacquer.</li> </ul>	
	80 x 60 x 22	1.197	1.293	1.487		
	80 x 80 x 22	1.315	1.420	1.633		
	120 x 45 x 22	1.269	1.370	1.576		
	120 x 60 x 22	1.417	1.531	1.760		
	120 x 80 x 22	1.558	1.683	1.935		
	160 x 45 x 22	1.465	1.583	1.820		
Freek coffee table 60 cm wide 	160 x 60 x 22	1.653	1.785	2.053		
	160 x 80 x 22	1.825	1.971	2.266		
	80 x 45 x 32	1.266	1.367	1.572		
	80 x 60 x 32	1.389	1.500	1.725		
	80 x 80 x 32	1.525	1.647	1.894		
	Freek coffee table 80 cm wide 	120 x 45 x 32	1.443	1.559		1.792
		120 x 60 x 32	1.612	1.740		2.002
120 x 80 x 32		1.777	1.919	2.207		
160 x 45 x 32		1.643	1.774	2.040		
160 x 60 x 32		1.844	1.992	2.291		
160 x 80 x 32		2.042	2.206	2.536		
80 x 45 x 42		1.266	1.367	1.572		
80 x 60 x 42		1.389	1.500	1.725		
80 x 80 x 42		1.525	1.647	1.894		
120 x 45 x 42		1.544	1.667	1.917		
120 x 60 x 42		1.722	1.860	2.139		
120 x 80 x 42		1.900	2.051	2.359		
160 x 45 x 42		1.745	1.884	2.167		
160 x 60 x 42		1.955	2.112	2.429		
160 x 80 x 42	2.167	2.340	2.691			
Freek coffee table square 60 x 60 	60 x 60 x 22	1.043	1.127	1.296		
	60 x 60 x 32	1.230	1.328	1.528		
	60 x 60 x 42	1.312	1.417	1.630		

# HOTZE coffee table

design: Gjalt Pilat, 2002

prices 2023 in euro excl. VAT

*custom sizes on request*

## dimensions

Hotze coffee table

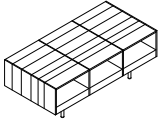

## L x W x H

3 compartments:

100 x 50 x 37,5

120 x 60 x 37,5

140 x 70 x 37,5

## beech

### light elm

### oak

### walnut

## key features / additional prices

- thickness of wood is 1/6 cm
- compartment height 15 cm
- standard steel legs, Ø21 x 150 mm, RAL 9004
- The finishing options are according to the solid wood samples such as presented in the current sample box.
- The prices are the same for all finishes; soap, oil, stain-lacquer, transparant lacquer and color lacquer.

1.132

1.223

1.406

1.453

1.570

1.805

1.657

1.790

2.058

# JACOBA coffee table set

design: Gjalt Pilat, 2019

prices 2023 in euro excl. VAT

custom sizes on request

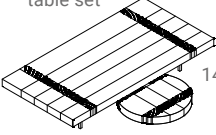
dimensions	L x W x H	light elm	walnut	key features / additional prices
Jacoba coffee table set 	120 x 60 x 27 rectangular + Ø 40 x 17 round	1.781	2.212	<ul style="list-style-type: none"> <li>• table top thickness is 7 cm</li> <li>• height rectangular model: 20 cm; round model 10 cm</li> <li>• legs solid steel 2 x 2 cm</li> <li>• supplied with felt pads and glides</li> <li>• Jacoba is designed as a coffee table set. The rectangular and round element is also offered separately.</li> <li>• Frame with coating in the standard colors RAL 9004 (black), RAL 9010 (white), Sikkens C4.40.30 (red), F6.05.50 (taupe) or E4.40.40 (caramel). Alternative colors are available on request</li> <li>• The finishing options are according to</li> <li>• the solid wood samples such as</li> <li>• presented in the current sample box.</li> <li>• The prices are the same for all finishes; soap, oil, stain-lacquer, transparent lacquer and color lacquer.</li> </ul>
	140 x 70 x 27 rectangular + Ø 50 x 17 round	1.958	2.432	
	160 x 80 x 27 rectangular + Ø 60 x 17 round	2.182	2.710	
	Jacoba coffee table round	Ø 40 x 17 Ø 50 x 17 Ø 60 x 17	698 750 817	
Jacoba coffee table rectangular	120 x 60 x 27	1.177	1.461	
	140 x 70 x 27	1.311	1.628	
	160 x 80 x 27	1.481	1.839	

# KLAAS coffee table

design: Trude van Assem, 2015

prices 2023 in euro excl. VAT

*custom sizes on request*

## dimensions

Klaas coffee table

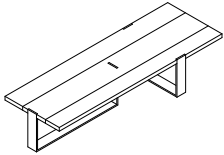

## L x W x H

150 x 50 x 30
175 x 50 x 30
200 x 50 x 30
150 x 75 x 30
175 x 75 x 30
200 x 75 x 30

## beech

### light elm

## oak

## walnut

1.402	1.514	1.665
1.549	1.673	1.840
1.697	1.832	2.016
1.843	1.990	2.189
2.059	2.223	2.446
2.275	2.457	2.703

## key features / additional prices

- thickness of tabletop is 3 cm
- tabletop is composed of full lengths and variable widths
- frame is made of steel size 8 x 1 cm
- frame parts and tabletop are dismountable
- in oak the tabletop is possible in a rustic version; cracks in the tabletop and open knots are filled with black coloured filler. This option does not affect the price.
- also see: Klaas table
- Frame with coating in the standard colors RAL 9004 (black), RAL 9010 (white), Sikkens C4.40.30 (red), F6.05.50 (taupe) or E4.40.40 (caramel). Alternative colors are available on request
- The finishing options are according to
- the solid wood samples such as
- presented in the current sample box.
- The prices are the same for all finishes; soap, oil, stain-lacquer, transparent lacquer and color lacquer.

# MEINT coffee table

design: Gjalt Pilat, 1995

prices 2023 in euro excl. VAT

*custom sizes on request*

## dimensions

## L x W x H

Meint coffee table

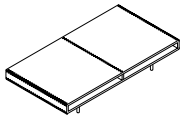

2 compartments:

140 x 61 x 25,5

160 x 61 x 25,5

140 x 76 x 25,5

160 x 76 x 25,5

140 x 91 x 25,5

160 x 91 x 25,5

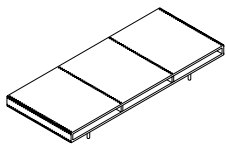

3 compartments:

180 x 76 x 25,5

200 x 76 x 25,5

220 x 76 x 25,5

180 x 91 x 25,5

200 x 91 x 25,5

220 x 91 x 25,5

## beech

### light elm

### oak

### walnut

## key features / additional prices

- thickness of wood 2 cm, compartment height 6 cm, total height 10 cm
- legs are 15 cm high
- legs standard stainless steel
- for steel legs with black coating a discount of 68,- applies
- The finishing options are according to
- the solid wood samples such as
- presented in the current sample box.
- The prices are the same for all finishes; soap, oil, stain-lacquer, transparant lacquer and color lacquer.

1.862

2.011

2.312

1.927

2.081

2.393

2.005

2.166

2.490

2.100

2.268

2.608

2.412

2.605

2.995

2.523

2.724

3.133

2.201

2.377

2.734

2.299

2.483

2.856

2.412

2.605

2.995

2.641

2.853

3.280

2.762

2.983

3.431

2.878

3.109

3.575



# SILAS coffee table set

design: Peter Tromop, 2021

prices 2023 in euro excl. VAT

*no customization possible*

## dimensions

Ø x H

oak

walnut

## key features / additional prices

Silas coffee table set 1

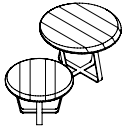

Silas small  
Ø 50 x 30  
Silas medium  
Ø 60 x 40

### set price

1.106

### set price

1.480

- table top margins have a gradient facet at the top and bottom
- Silas coffee tables delivered assembled
- Steel parts coated on the frame, color RAL 9004
- Silas is designed as a coffee table set
- The prices are the same for all finishes; soap, oil, stain-lacquer, transparent lacquer and color lacquer.

Silas coffee table set 2

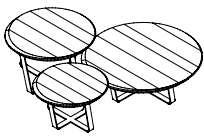

Silas small  
Ø 50 x 30  
Silas medium  
Ø 60 x 40  
Silas large  
Ø 80 x 25

### set price

2.134

### set price

2.454

Silas coffee tables

3 sizes (loose)



Silas small  
Ø 50 x 30

507

678



Silas medium  
Ø 60 x 40

692

925

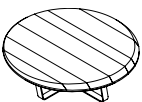

Silas large  
Ø 80 x 25

1.033

1.188

# SYTO small table & coffee tables

design: Gjalt Pilat, 2021

prices 2023 in euro excl. VAT

*no customization possible*

## dimensions

Ø x H

light elm

oak

walnut

## key features / additional prices

Syto small table/stool



Ø 35 x 46

289

312

359

- thickness of top 4 cm
- the coffee tables have a table top finished with a facet (see illustration below)
- The finishing options are according to the solid wood samples such as presented in the current sample box.
- The prices are the same for all finishes; soap, oil, stain-lacquer, transparent lacquer and color lacquer.

Syto coffee table

table top diameter 60 cm



Ø 60 x 37

665

718

826

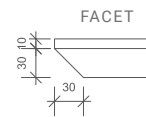

Syto coffee table

table top diameter 70 cm

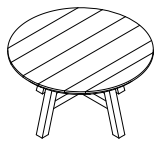

Ø 70 x 37

728

786

904

# TIEMEN I coffee table

design: Gjalt Pilat, 2009

prices 2023 in euro excl. VAT

custom sizes on request

## dimensions

Tiemen I coffee table

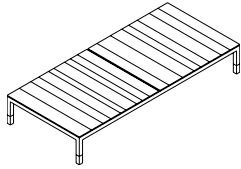

## L x W x H

120 x 50 x 30  
140 x 60 x 30  
160 x 70 x 30  
180 x 70 x 30  
200 x 75 x 30

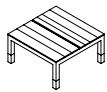

50 x 50 x 30  
60 x 60 x 30  
70 x 70 x 30  
80 x 80 x 30  
90 x 90 x 30  
100 x 100 x 30

## beech

### light elm

### oak

### walnut

1.245  
1.311  
1.411  
1.470  
1.522

1.344  
1.416  
1.524  
1.587  
1.644

1.479  
1.557  
1.677  
1.746  
1.808

## key features / additional prices

- tabletop thickness 2 cm, of which 1 cm is visible
- legs and frame frame 3 x 3 cm
- composition from whole lengths of wood, transverse to the direction of the table
- the open joint of 1.5 cm in the middle of the tabletop is necessary, due to the warping of the wood
- Frame with coating in the standard colors RAL 9004 (black), RAL 9010 (white), Sikkens C4.40.30 (red), F6.05.50 (taupe) or E4.40.40 (caramel). Alternative colors are available on request
- also see Tiemen II and Tiemen table
- The finishing options are according to the solid wood samples such as presented in the current sample box.
- The prices are the same for all finishes; soap, oil, stain-lacquer, transparant lacquer and color lacquer.

# TIEMEN II coffee table

design: Gjalt Pilat, 2009

custom sizes on request

## dimensions

Tiemen II coffee table

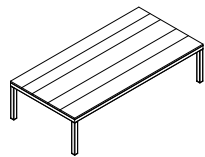

## L x W x H

120 x 50 x 30  
140 x 60 x 30  
160 x 70 x 30  
180 x 70 x 30  
200 x 75 x 30

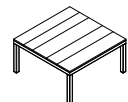

50 x 50 x 30  
60 x 60 x 30  
70 x 70 x 30  
80 x 80 x 30  
90 x 90 x 30  
100 x 100 x 30

## beech

### light elm

### oak

### walnut

1.245  
1.311  
1.411  
1.470  
1.522

1.344  
1.416  
1.524  
1.587  
1.644

1.479  
1.557  
1.677  
1.746  
1.808

## key features / additional prices

- tabletop thickness 3 cm, of which 1 cm is visible
- legs and frame frame 3 x 3 cm
- composition from whole lengths of wood, in the longitudinal direction of the table
- Frame with coating in the standard colors RAL 9004 (black), RAL 9010 (white), Sikkens C4.40.30 (red), F6.05.50 (taupe) or E4.40.40 (caramel). Alternative colors are available on request
- also see Tiemen I and Tiemen table
- The finishing options are according to the solid wood samples such as presented in the current sample box.
- The prices are the same for all finishes; soap, oil, stain-lacquer, transparant lacquer and color lacquer.

**PILAT &  
PILAT**

# SMALL TABLES

prices 2023 in euro excl. VAT

customization not possible

dimensions

L x W x H

light elm

oak

walnut

key features / additional prices

## ANNEBETH

design: Gjalt Pilat, 2009

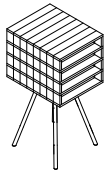

26 x 32 x 62

\* 606

654

753

- legs of coated steel RAL9004 (black)
- height legs 37 cm
- \* Annebeth is also possible in beech
- The finishing options are according to the solid wood samples such as presented in the current sample box.
- The prices are the same for all finishes; soap, oil, stain-lacquer, transparent lacquer and color lacquer.

## EIRIK

design: Peter Tromop, 2007

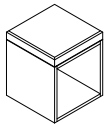

30 x 30 x 35

345

372

428

- The finishing options are according to the solid wood samples such as presented in the current sample box.
- The prices are the same for all finishes; soap, oil, stain-lacquer, transparent lacquer and color lacquer.
- also see Eirik cupboard

## HILDE HYK

design: Gjalt Pilat, 2009

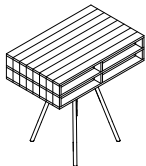

51 x 32 x 50

\* 597

645

742

- legs of coated steel RAL9004 (black)
- height legs 37 cm
- \* Hilde Hyk is also possible in beech
- The finishing options are according to the solid wood samples such as presented in the current sample box.
- The prices are the same for all finishes; soap, oil, stain-lacquer, transparent lacquer and color lacquer.

## HYKE

design: Gjalt Pilat, 2009

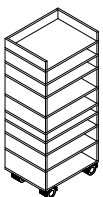

34 x 26 x 75,5

686

741

852

- on black swivel wheels
- The finishing options are according to the solid wood samples such as presented in the current sample box.
- The prices are the same for all finishes; soap, oil, stain-lacquer, transparent lacquer and color lacquer.

## NEL

design: Peter Tromop, 2009

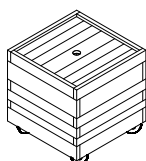

40 x 40 x 45

645

696

801

- on black swivel wheels with total stop brake
- The finishing options are according to the solid wood samples such as presented in the current sample box.
- The prices are the same for all finishes; soap, oil, stain-lacquer, transparent lacquer and color lacquer.

# SMALL TABLES

prices 2023 in euro excl. VAT

customization not possible

dimensions

L x W x H

light elm

oak

walnut

key features / additional prices

## PAKE SYTSE

design: Gjalt Pilat, 2015



Ø 50 x 37

471

509

585

- thickness of tabletop 3 cm
- frame is made of 3 x 3 cm solid wood
- The finishing options are according to the solid wood samples such as presented in the current sample box.
- The prices are the same for all finishes; soap, oil, stain-lacquer, transparent lacquer and color lacquer.
- also see Pake Sytse table and Syto stool

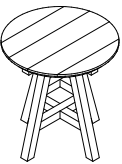

Ø 50 x 52

505

546

628

## SIEBREN SMALL

design: Gjalt Pilat, 2009

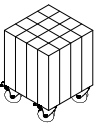

28 x 28 x 40

466

579

- on black swivel wheels with total stop brake
- The finishing options are according to the solid wood samples such as presented in the current sample box.
- The prices are the same for all finishes; soap, oil, stain-lacquer, transparent lacquer and color lacquer.
- \* Siebren is not possible in oak

## SIEBREN LARGE

design: Gjalt Pilat, 2009

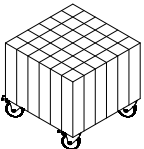

42 x 42 x 40

597

742

- on black swivel wheels with total stop brake
- The finishing options are according to the solid wood samples such as presented in the current sample box.
- The prices are the same for all finishes; soap, oil, stain-lacquer, transparent lacquer and color lacquer.
- \* Siebren is not possible in oak

## SYL

design: Bas van der Veer, 2014

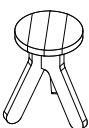

Ø 30 x 45

280

303

348

- The finishing options are according to the solid wood samples such as presented in the current sample box.
- The prices are the same for all finishes; soap, oil, stain-lacquer, transparent lacquer and color lacquer.

# DESKS

prices 2023 in euro excl. VAT

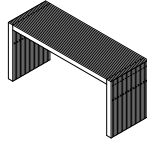

**BAS**  
page 46

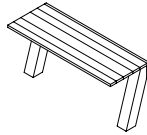

**JONAS II**  
page 47

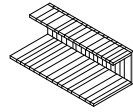

**KEES**  
page 48

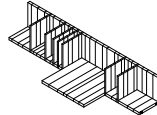

**LUTGARDE**  
page 49

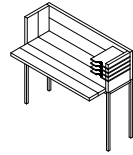

**WILKE**  
page 50

# BAS desk

design: Gjalte Pilat, 2001

prices 2023 in euro excl. VAT

*custom sizes on request*

## dimensions

Bas desk

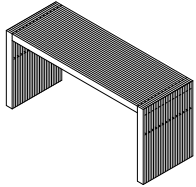

## W x D x H

140 x 62 x 76

160 x 62 x 76

180 x 62 x 76

## light elm

1.847

1.971

2.111

## oak

1.995

2.129

2.280

## walnut

2.294

2.448

2.622

## key features / additional prices

- made of 6,8 cm thick wood
- composed of various lengths from 40 to 100 cm
- The finishing options are according to the solid wood samples such as presented in the current sample box.
- The prices are the same for all finishes; soap, oil, stain-lacquer, transparent lacquer and color lacquer.

# JONAS II desk

design: Gjalt Pilat, 2006

prices 2023 in euro excl. VAT

*custom sizes on request*

## dimensions

## W x D x H

Jonas II desk

140 x 60 x 76

160 x 60 x 76

180 x 60 x 76

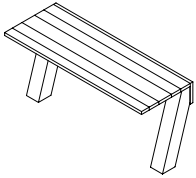

Jonas II desk

140 x 60 x 76

fenix worksheet

160 x 60 x 76

180 x 60 x 76

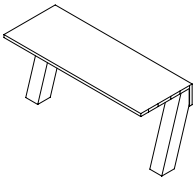

## beech

### light elm

### oak

### walnut

1.496

1.615

1.857

1.561

1.686

1.939

1.603

1.731

1.991

1.645

1.777

2.043

1.717

1.855

2.133

1.764

1.905

2.191

## key features / additional prices

- thickness of worksheet 3 cm
- size legs 14x14 cm, felt on the underside
- is mounted on the wall
- for Fenix top layers the following standard colors apply:
  - 0029 Bianco Malé
  - 0720 Nero Ingo
  - 0717 Castoro Ottawa
- The finishing options are according to the solid wood samples such as presented in the current sample box.
- The prices are the same for all finishes; soap, oil, stain-lacquer, transparent lacquer and color lacquer.



# KEES desk

design: Gjalte Pilat, 2007

prices 2023 in euro excl. VAT

*custom sizes on request*

## dimensions

**W x D x H**

Kees desk

120 x 57 x 40

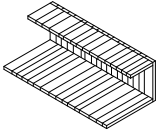

## beech

**light elm**

**oak**

**walnut**

## key features / additional prices

1.464

1.581

1.818

- thickness of tabletop 3 cm
- desk is attached to four hooks that are screwed into the wall
- The finishing options are according to the solid wood samples such as presented in the current sample box.
- The prices are the same for all finishes; soap, oil, stain-lacquer, transparent lacquer and color lacquer.

# LUTGARDE desk

design: Gjalt Pilat, 2012

prices 2023 in euro excl. VAT

*custom sizes on request*

## dimensions

## W x D x H

Lutgarde desk

187 x 30/60 x 33

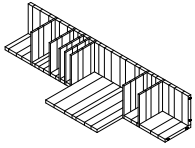

## beech

### light elm

2.191

### oak

2.366

### walnut

2.721

## key features / additional prices

- thickness of tabletop 3 cm
- desk is attached to four hooks that are screwed into the wall
- also see: Lutgarde shelving unit
- The finishing options are according to the solid wood samples such as presented in the current sample box.
- The prices are the same for all finishes; soap, oil, stain-lacquer, transparent lacquer and color lacquer.

# WILKE desk

design: Gjalt Pilat, 2012

prices 2023 in euro excl. VAT

*custom sizes on request*

## dimensions

## W x D x H

Wilke desk

120 x 60 x 107,5

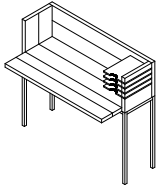

## light elm

2.303

## oak

2.487

## walnut

2.860

## key features / additional prices

- thickness of desk top 3,6 cm
- height desk top 76 cm
- frame is made of solid steel
- Frame with coating in the standard colors RAL 9004 (black), RAL 9010 (white), Sikkens C4.40.30 (red), F6.05.50 (taupe) or E4.40.40 (caramel). Alternative colors are available on request
- The finishing options are according to the solid wood samples such as presented in the current sample box.
- The prices are the same for all finishes; soap, oil, stain-lacquer, transparent lacquer and color lacquer.

# BENCHES

prices 2023 in euro excl. VAT

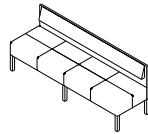

**AMARINZ**  
page 52

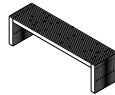

**BAS**  
page 53

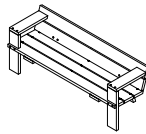

**BERTHE  
OUTDOOR**  
page 54

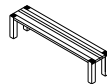

**DORUS**  
page 55



**DÛBELD**  
page 56

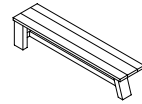

**ELIZABETH II**  
page 57

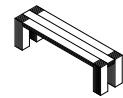

**HINDRIK  
LANGSHOUT**  
page 58

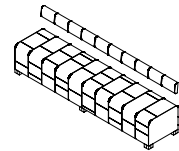

**HINKE**  
page 59

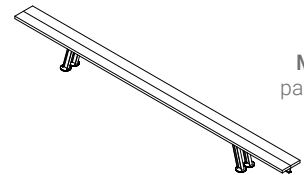

**MADS**  
page 60

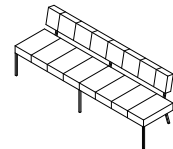

**MARJELLE**  
page 61

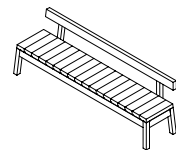

**WYBE**  
page 62/63

# AMARINZ bench

design: Gjalt Pilat, 2011

prices 2023 in euro excl. VAT

*custom sizes on request*

## dimensions

## W x D x H

Amarinz bench

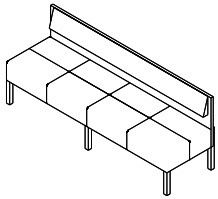

160 x 59 x 78
180 x 59 x 78
200 x 59 x 78
220 x 59 x 78
240 x 59 x 78
260 x 59 x 78
280 x 59 x 78
300 x 59 x 78
320 x 59 x 78

## light elm

2.663
2.911
3.157
3.405
3.652
3.777
3.900
4.146
4.393

## oak

2.876
3.144
3.410
3.678
3.944
4.079
4.212
4.478
4.744

## walnut

3.163
3.458
3.750
4.046
4.339
4.487
4.633
4.926
5.219

## key features / additional prices

- possible leathers: Ohman Nero, Dark Brown, Havana furthermore sheepskin leather light brown, dark brown and black.
- stitching in three possible colours: black, brown or sand colour. Please mention your choice when ordering
- The finishing options are according to
- the solid wood samples such as
- presented in the current sample box.
- The prices are the same for all finishes; soap, oil, stain-lacquer, transparant lacquer and color lacquer.
- customers own material on request.

# BAS bench

design: Gjalt Pilat, 2001

prices 2023 in euro excl. VAT

*custom sizes on request*

## dimensions

Bas bench

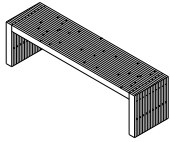

## W x D x H

160 x 42 x 45
180 x 42 x 45
200 x 42 x 45
220 x 42 x 45
240 x 42 x 45

## light elm

1.539
1.558
1.588
1.640
1.694

## oak

1.662
1.683
1.715
1.771
1.830

## walnut

1.911
1.935
1.973
2.037
2.104

## key features / additional prices

- thickness of wood 6,8 cm
- composition of variable lengths, from 40 to 100 cm
- also see: Bas table
- The finishing options are according to
- the solid wood samples such as
- presented in the current sample box.
- The prices are the same for all finishes; soap, oil, stain-lacquer, transparant lacquer and color lacquer.

# BERTHE bench outdoor

design: Gjalt Pilat / Peter Tromp, 2007

prices 2023 in euro excl. VAT

*no customization possible*

## dimensions

**W x D x H**

Berthe bench

200 x 65 x 74

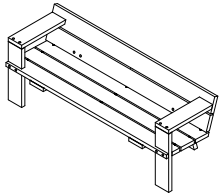

**douglas**

**untreated**

1.673

## key features / additional prices

- seat height 40 cm, seat depth 49 cm
- height arm rests 67 cm
- thickness of wood 4 cm
- metal parts are brass
- untreated douglas becomes gray over time

# DORUS bench

design: Gjalt Pilat, 1998

prices 2023 in euro excl. VAT

*custom sizes on request*

## dimensions

Dorus bench

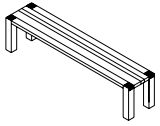

## W x D x H

160 x 42 x 45
180 x 42 x 45
200 x 42 x 45
220 x 42 x 45
240 x 42 x 45

## light elm

1.319
1.368
1.613
1.684
1.750

## oak

1.424
1.478
1.742
1.818
1.890

## walnut

1.638
1.699
2.004
2.091
2.173

## key features / additional prices

- thickness of seat 4 cm
- the leg of a Dorus table is 8,8 x 8,8 cm
- also see: Dorus table
- The finishing options are according to
- the solid wood samples such as
- presented in the current sample box.
- The prices are the same for all finishes; soap, oil, stain-lacquer, transparent lacquer and color lacquer.



# DÛBELD storage seatbox

design: Kristien Pilat, 2008

prices 2023 in euro excl. VAT

*custom sizes on request*

## dimensions

## W x D x H

Dûbeld storage seatbox

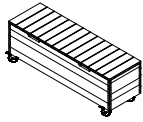

126 x 39 x 44,5  
144 x 39 x 44,5  
162 x 39 x 44,5  
180 x 39 x 44,5

## light elm

1.443  
1.502  
1.563  
1.621

## oak

1.559  
1.623  
1.688  
1.751

## walnut

1.792  
1.866  
1.941  
2.013

## key features / additional prices

- on black castors with total stop brake
- 2 flaps with a damping closing system
- bottom of solid wood
- The finishing options are according to
- the solid wood samples such as
- presented in the current sample box.
- The prices are the same for all finishes; soap, oil, stain-lacquer, transparent lacquer and color lacquer.

# ELIZABETH II bench

design: Gjalt Pilat, 2004

prices 2023 in euro excl. VAT

*custom sizes on request*

## dimensions

## W x D x H

Elizabeth II bench, 3 legs

160 x 45 x 45

170 x 45 x 45

180 x 45 x 45

200 x 45 x 45

220 x 45 x 45

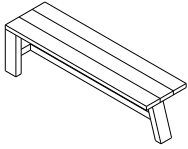

Elizabeth II bench, 4 legs

240 x 45 x 45

260 x 45 x 45

280 x 45 x 45

300 x 45 x 45

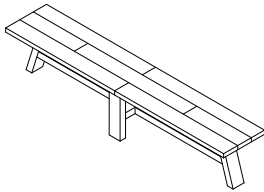

## light elm

## oak

## walnut

## key features / additional prices

1.441

1.557

1.790

- from 160 cm on three legs

1.472

1.590

1.829

- from 240 cm on four legs

1.502

1.622

1.865

- from 260 cm the seating panel is composed of two or three lengths as shown on the pictures

1.557

1.682

1.934

- the legs measure 6 x 12 cm

1.612

1.740

2.002

- also see: Elizabeth II table

- The finishing options are according to

- the solid wood samples such as

- presented in the current sample box.

- The prices are the same for all finishes; soap and / or oil, stain-lacquer, transparent lacquer and colour lacquer.

1.922

2.076

2.387

2.143

2.314

2.661

2.188

2.363

2.718

2.234

2.413

2.774

# HINDRIK LANGSHOUT bench

design: Gjal't Pilat, 2004

prices 2023 in euro excl. VAT

custom sizes on request

## dimensions

## W x D x H

## light elm

## oak

## walnut

## key features / additional prices

Hindrik Langshout bench

160 x 40,5 x 45

1.702

1.838

2.114

- from 240 cm on four legs

180 x 40,5 x 45

1.789

1.932

2.221

- from 320 cm on six legs

200 x 40,5 x 45

1.872

2.022

2.325

- the seat panel of the Hindrik Langshout bench is composed of fixed widths of 13,5 x 13,5 cm

220 x 40,5 x 45

1.959

2.116

2.433

240 x 40,5 x 45

2.045

2.208

2.540

- the legs measure 13,5 x 13,5 cm

260 x 40,5 x 45

2.130

2.300

2.645

- from 260 cm the seat panel is composed of two or three lengths as shown on the pictures

280 x 40,5 x 45

2.216

2.393

2.752

- also see: Hindrik Langshout table

300 x 40,5 x 45

2.302

2.486

2.859

- The finishing options are according to

320 x 40,5 x 45

2.475

2.672

3.073

- the solid wood samples such as

340 x 40,5 x 45

2.560

2.765

3.180

- presented in the current sample box.

360 x 40,5 x 45

2.646

2.858

3.287

- The prices are the same for all finishes;

380 x 40,5 x 45

2.732

2.950

3.393

- soap, oil, stain-lacquer, transparant lacquer and color lacquer.

400 x 40,5 x 45

2.817

3.043

3.499

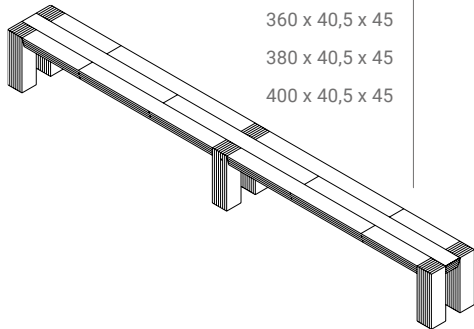
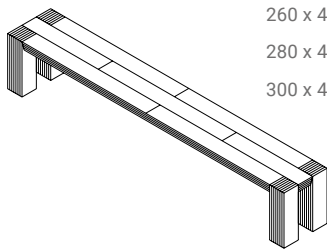
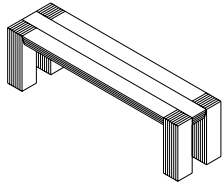

# HINKE bench

design: Gjal't Pilat, 2010

prices 2023 in euro excl. VAT

*custom sizes on request*

## dimensions

## W x D x H

Hinke bench with backrest

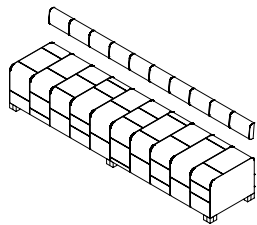

180 x 55 x 48
200 x 55 x 48
220 x 55 x 48
240 x 55 x 48
260 x 55 x 48
280 x 55 x 48
300 x 55 x 48
320 x 55 x 48
340 x 55 x 48

## lined with leather

## without backrest

2.289	1.734
2.469	1.857
2.649	1.981
2.803	2.083
2.932	2.159
3.035	2.212
3.136	2.265
3.240	2.320
3.390	2.414

## key features / additional prices

- please mention the kind of wood of the legs when ordering (oak/light elm/walnut)
- backrest mounted on the wall
- possible leathers: Ohman Nero, Dark Brown, Havana furthermore sheepskin leather light brown, dark brown and black.
- stitching in three possible colours; black, brown or sand colour.
- customers own material on request.

# MADS bench

design: Gjalt Pilat, 2015

prices 2023 in euro excl. VAT

*custom sizes on request*

## dimensions

## W x D x H

## light elm

## oak

## walnut

## key features / additional prices

300 x 33 x 47

1.970

2.128

•

• also see: Mads table

350 x 33 x 47

2.042

2.206

•

• Frame with coating in the standard

400 x 33 x 47

2.116

2.285

•

colors RAL 9004 (black), RAL 9010

450 x 33 x 47

2.188

2.363

•

(white), Sikkens C4.40.30 (red), F6.05.50

500 x 33 x 47

2.261

2.442

•

(taupe) or E4.40.40 (caramel). Alternative

colors are available on request

• the seat consists of 2 to 4 parts with

a total width of 33 cm

• The finishing options are according to

• the solid wood samples such as

• presented in the current sample box.

• The prices are the same for all finishes;

soap and / or oil, stain-lacquer,

transparent lacquer and colour lacquer.

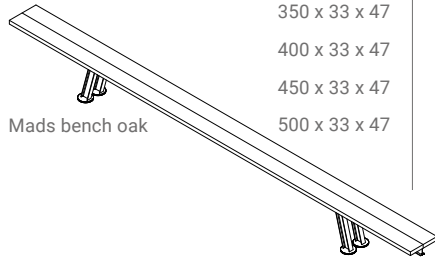

Mads bench oak

300 x 33 x 47

1.871

2.021

2.223

350 x 33 x 47

1.939

2.094

2.304

400 x 33 x 47

2.010

2.170

2.387

450 x 33 x 47

2.078

2.245

2.469

500 x 33 x 47

2.148

2.320

2.552

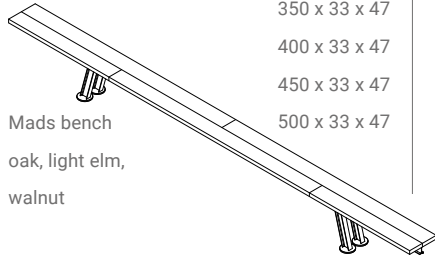

Mads bench  
oak, light elm,  
walnut

# MARJELLE bench

design: Gjalt Pilat, 2019

prices 2023 in euro excl. VAT

*custom sizes on request*

dimensions	W x D x H
Marjelle bench	121 x 67 x 78
	141 x 67 x 78
	161 x 67 x 78
	181 x 67 x 78
	201 x 67 x 78
	221 x 67 x 78
	241 x 67 x 78
	261 x 67 x 78
	281 x 67 x 78
	301 x 67 x 78

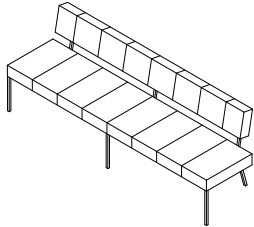

## cow leather

### sheep leather

### customers own request

*fabric required*

## key features / additional prices

- seat height approx. 49 cm, net
- seat depth approx. 47 cm
- possible cow leathers: Ohmann Nero, Dark Brown, Havana, furthermore sheep leathers: light brown, dark brown and black
- stitching in three possible colours; black, brown or sand colour. please mention your choice when ordering
- COM (customers own material) excludes fabric and includes upholstery
- submit fabric
- Frame with coating in the standard colors RAL 9004 (black), RAL 9010 (white), Sikkens C4.40.30 (red), F6.05.50 (taupe) or E4.40.40 (caramel). Alternative colors are available on request
- supplied with felt pads and glides

# WYBE bench WITH WOODEN BACKREST

design: Gjalt Pilat, 2017

prices 2023 in euro excl. VAT

custom sizes on request

## dimensions

## W x D x H

## light elm

## walnut

fabric  
required

## key features / additional prices

Wybe bench with  
wooden backrest  
(4 legs until length 280)

200 x 61,5 x 79

2.164

2.571

1,7 meters

COM

1.644

1.953

220 x 61,5 x 79

2.236

2.657

1,8 meters

COM

1.699

2.019

240 x 61,5 x 79

2.309

2.744

1,9 meters

COM

1.755

2.085

260 x 61,5 x 79

2.391

2.841

2,1 meters

COM

1.817

2.159

280 x 61,5 x 79

2.472

2.937

2,2 meters

COM

1.878

2.231

Wybe bench with  
wooden backrest  
(6 legs from length 300)

300 x 61,5 x 79

2.927

3.478

2,3 meters

COM

2.224

2.643

320 x 61,5 x 79

3.119

3.706

2,4 meters

COM

2.371

2.816

340 x 61,5 x 79

3.315

3.938

2,6 meters

COM

2.519

2.993

360 x 61,5 x 79

3.512

4.172

2,7 meters

COM

2.670

3.172

380 x 61,5 x 79

3.709

4.406

2,9 meters

COM

2.818

3.348

400 x 61,5 x 79

3.859

4.585

3,0 meters

COM

2.933

3.485

- the legs measure 6 x 6 cm
- possible leathers: Ohman Nero, Dark Brown, Havana furthermore sheepskin leather light brown, dark brown and black.
- stitching in three possible colours; black, brown or sand colour. please mention your choice when ordering
- COM (customers own material) excludes fabric and includes upholstery
- submit fabric
- this model is only available in light elm and walnut.
- The finishing options are according to
- the solid wood samples such as
- presented in the current sample box.
- The prices are the same for all finishes; soap and / or oil, stain-lacquer, transparent lacquer and colour lacquer.
- also see: Wybe table

# WYBE bench WITH UPHOLSTERED BACKREST

design: Gjalt Pilat, 2017

prices 2023 in euro excl. VAT

custom sizes on request

## dimensions

## W x D x H

## light elm

## walnut

## fabric required

## key features / additional prices

Wybe bench with upholstered backrest (4 legs until length 280)

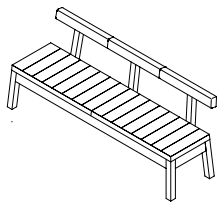

220 x 61,5 x 79  
COM

2.522  
1.917

2.996  
2.277

2,6 meters

- the legs measure 6 x 6 cm
- possible leathers: Ohman Nero, Dark Brown, Havana furthermore sheepskin leather light brown, dark brown and black.

220 x 61,5 x 79  
COM

2.615  
1.988

3.107  
2.362

2,8 meters

- stitching in three possible colours;; black, brown or sand colour.

240 x 61,5 x 79  
COM

2.713  
2.062

3.224  
2.450

3,0 meters

- please mention your choice when ordering

260 x 61,5 x 79  
COM

2.869  
2.180

3.408  
2.589

3,2 meters

- COM (customers own material) excludes fabric and includes upholstery

280 x 61,5 x 79  
COM

3.008  
2.286

3.574  
2.716

3,4 meters

- submit fabric
- this model is only available in light elm and walnut.

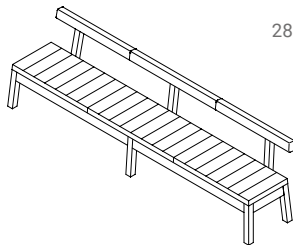

Wybe bench with upholstered backrest (4 legs until length 280)

300 x 61,5 x 79  
COM

3.411  
2.592

4.052  
3.080

3,6 meters

- The finishing options are according to

320 x 61,5 x 79  
COM

3.634  
2.762

4.317  
3.281

the solid wood samples such as

- presented in the current sample box.

340 x 61,5 x 79  
COM

3.863  
2.935

4.589  
3.487

3,8 meters

- The prices are the same for all finishes;

360 x 61,5 x 79  
COM

4.091  
3.110

4.860  
3.694

4,0 meters

- soap and / or oil, stain-lacquer, transparent lacquer and colour lacquer.

380 x 61,5 x 79  
COM

4.320  
3.284

5.132  
3.902

4,2 meters

- also see: Wybe table

400 x 61,5 x 79  
COM

4.497  
3.417

5.342  
4.060

4,4 meters

4,6 meters





# ARMCHAIRS CHAIRS

prices 2023 in euro excl. VAT

## ARMCHAIRS



**KRISTIEN**  
page 66



**LUDY**  
page 67



**TOUTER**  
page 68

## CHAIRS



**DINY**  
page 69



**FROUKJE III**  
page 70



**GRETA**  
page 71



**HITOSHI**  
page 72



**KOOS**  
page 73



**LUTSKE**  
page 74



**PAS**  
page 75



**SYL**  
page 76



**SYTO**  
page 77

# KRISTIEN armchair

design: Gjalt Pilat, 2011

prices 2023 in euro excl. VAT

*no customization possible*

## dimensions

### W x D x H

Kristien armchair

64 x 85 x 63,5

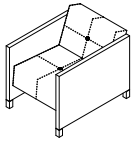

Kristien armchair  
in leather  
(including leather)

Kristien armchair  
own fabric  
excluding fabric  
including upholstery

### light elm

### oak

### walnut

2.052

2.216

2.437

1.710

1.846

2.031

## key features / additional prices

- width 64 cm, depth 85 cm, height 63.6 cm
- possible leathers: Ohman Nero, Dark Brown, Havana furthermore sheepskin leather light brown, dark brown and black.
- stitching in three possible colours: black, brown or sand colour.  
please mention your choice when ordering
- COM (customers own material) excludes fabric and includes upholstery
- submit fabric: 2,3 meters for 1 armchair
- The finishing options are according to the solid wood samples such as presented in the current sample box.
- The prices are the same for all finishes; soap, oil, stain-lacquer, transparent lacquer and color lacquer.

# LUDY armchair

design: Gjalt Pilat, 2019

prices 2023 in euro excl. VAT

no customization possible

## dimensions

W x D x H

Ludy armchair

80 x 78 x 71



cow  
leather

sheep  
leather

customers  
own  
material

fabric  
required

1.522

1.202

1,3 meters

## key features / additional prices

- seat height approx. 40 cm, net seat depth approx. 50 cm, armrest height approx. 62 cm
- possible cow leathers: Ohmann Nero, Dark Brown, Havana, furthermore sheep leathers: light brown, dark brown and black
- stitching in three possible colours; black, brown or sand colour. please mention your choice when ordering
- COM (customers own material) excludes fabric and includes upholstery
- submit fabric
- Frame with coating in the standard colors RAL 9004, RAL 9010, Sikkens C4.40.30 or F6.05.50. Alternative colors are available on request
- supplied with glides and felts
- finishing possibilities according to the solid wood samples as presented in a current sample box
- The prices are the same for all finishes; soap, oil, stain-lacquer, transparant lacquer and color lacquer.

# TOUTER rocking chair

design: Kristien Pilat, 2007

prices 2023 in euro excl. VAT

*no customization possible*

## dimensions

## W x D x H

## light elm

## oak

## walnut

## key features / additional prices

Touter rocking chair

98 x 63 x 76

573

619

712

- The finishing options are according to the solid wood samples such as presented in the current sample box.
- The prices are the same for all finishes; soap, oil, stain-lacquer, transparent lacquer and color lacquer.



# DINY chair

design: Kristien Pilat, 2014

prices 2023 in euro excl. VAT

*no customization possible*

## dimensions

### W x D x H

Diny chair

55,5 x 54 x 86



### leather

811

876

964

### COM

756

817

899

excluding fabric  
including upholstery

## key features / additional prices

- possible leathers: Ohman Nero, Dark Brown, Havana furthermore sheepskin leather light brown, dark brown and black.
- stitching in three possible colours: black, brown or sand colour.  
please mention your choice when ordering
- width 55.5 cm, depth 54 cm, height 86 cm, height armrest 65 cm
- the amount of fabric is determined by the number of chairs:  
1 chair 0,60 m | 4 chairs 1,20 m  
2 chairs 0,60 m | 5 chairs 1,80 m  
3 chairs 1,20 m | 6 chairs 1,80 m
- submit fabric
- finishing possibilities according to the solid wood samples as presented in a current sample box
- The prices are the same for all finishes; soap, oil, stain-lacquer, transparant lacquer and color lacquer.

# FROUKJE chair

design: Gjalt Pilat, 2015

prices 2023 in euro excl. VAT

*no customization possible*

## dimensions

## W x D x H

Froukje III chair

56,5 x 60 x 81



## fully upholstered

## key features / additional prices

### Froukje III chair in leather:

including leather  
including upholstery

864

- possible leathers: Ohman Nero, Dark Brown, Havana furthermore sheepskin leather light brown, dark brown and black.

- stitching in three possible colours; black, brown or sand colour.

- please mention your choice when ordering

- Frame with coating in the standard colors RAL 9004 (black), RAL 9010 (white), Sikkens C4.40.30 (red), F6.05.50 (taupe) or E4.40.40 (caramel). Alternative colors are available on request

- cockpit inside front: width 47 cm, back: 38 cm, seat depth 48 cm, height of armrest 68 cm.

- the amount of fabric is determined by the number of chairs:

1 chair 1,90 m | 4 chairs 6,30 m

2 chairs 3,15 m | 5 chairs 8,20 m

3 chairs 5,05 m | 6 chairs 9,15 m

- submit fabric

### Froukje III chair in COM

excluding fabric  
including upholstery

511

# GRETA chair

design: Gjalt Pilat, 2005

prices 2023 in euro excl. VAT

*no customization possible*

## dimensions

## W x D x H

Greta chair

45 x 54,5 x 82



## light elm

668

## oak

721

## walnut

829

## key features / additional prices

- seat height 45 cm
- Finishing possibilities according to the solid wood samples as presented in a current sample box
- The prices are the same for all finishes; soap, oil, stain-lacquer, transparent lacquer and color lacquer.



# HITOSHI chair

design: Bart Vos, 2022

prices 2023 in euro excl. VAT

*no customization possible*

## dimensions

## W x D x H

Hitoshi chair

56 x 62 x 87

Hitoshi chair in leather  
(including leather)

Hitoshi chair own fabric  
excluding fabric  
including upholstery

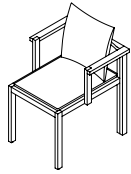

## oak

## walnut

## key features / additional prices

719

791

817

899

- width 56 cm, depth 62 cm, height 87 cm
- armrest height 70 cm
- possible leathers: Ohman Nero, Dark Brown, Havana furthermore sheepskin leather light brown, dark brown and black.
- COM (customers own material) excludes fabric and includes upholstery
- submit fabric: 1 meter for 1 chair
- required fabric becomes determined by number of chairs:
  - 2 chairs 1,70 m
  - 4 chairs 3,40 m
  - 6 chairs 5,10 m
- The finishing options are according to
- the solid wood samples such as
- presented in the current sample box.
- The prices are the same for all finishes; soap, oil, stain-lacquer, transparant lacquer and color lacquer.

# KOOS chair

design: Kristien Pilat 2000/2021

prices 2023 in euro excl. VAT

*no customization possible*

## dimensions

## W x D x H

Koos chair

47 x 52 x 85



## COM

excluding fabric  
including upholstery

## light elm

511

## oak

552

## walnut

608

## key features / additional prices

- seat height 45 cm
- COM (customers own material) excludes fabric and includes upholstery
- the amount of fabric is determined by the number of chairs:
  - 1 chair 0,70 m
  - 2 chairs 1,35 m
  - 4 chairs 2,70 m
- submit fabric
- removable cover
- Finishing possibilities according to the solid wood samples as presented in a current sample box
- The prices are the same for all finishes; soap, oil, stain-lacquer, transparant lacquer and color lacquer.

# LUTSKE chair

design: Gjal't Pilat, 1997

prices 2023 in euro excl. VAT

*no customization possible*

## dimensions

### W x D x H

Lutske chair

41,5 x 49,5 x 85



## light elm

537

## oak

580

## walnut

667

## key features / additional prices

- seat height 46 cm
- Standard color of the steel parts:
- RAL 9004. A coating in another RAL or Sikkens color is possible. Please indicate the color choice when ordering.
- finishing possibilities according to the solid wood samples as presented in a current sample box
- The prices are the same for all finishes; soap, oil, stain-lacquer, transparent lacquer and color lacquer.

# PAS chair

design: Gjalte Pilat, 2014

prices 2023 in euro excl. VAT

*no customization possible*

## dimensions

## W x D x H

## light elm

## oak

## walnut

## key features / additional prices

Pas chair

49 x 59 x 72,5

444

480

552

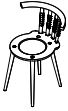

- height of seat: 46,5 cm
- finishing possibilities according to the solid wood samples as presented in a current sample box
- The prices are the same for all finishes; soap, oil, stain-lacquer, transparent lacquer and color lacquer.
- in addition, a combination of color and transparent lacquer is possible, in which chair legs and bottom of the seat are spraypainted in color and the top of the seat and the back are spraypainted transparently.

# SYL stool

design: Bas van der Veer, 2015

prices 2023 in euro excl. VAT

*no customization possible*

## dimensions

Ø x H

light elm

oak

walnut

## key features / additional prices

Syl stool

Ø 30 x 45

280

303

348

- finishing possibilities according to the solid wood samples as presented in a current sample box
- The prices are the same for all finishes; soap, oil, stain-lacquer, transparant lacquer and color lacquer.



# SYTO stool

design: Gjalt Pilat, 2021

prices 2023 in euro excl. VAT

*no customization possible*

## dimensions

Ø x H

light elm

oak

walnut

## key features / additional prices

Syto stool

Ø35 x 46

289

312

359

- seat thickness 4 cm
- finishing possibilities according to the solid wood samples as presented in a current sample box
- The prices are the same for all finishes; soap, oil, stain-lacquer, transparent lacquer and color lacquer.





# CABINETS SIDEBOARDS SHELVING UNITS

prices 2023 in euro excl. VAT



BEREND  
cabinet series  
page 80-86

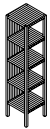

DIEDERIK  
shelving unit  
page 87

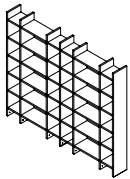

EDWARD  
shelving unit  
page 88

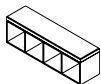

EIRIK  
shelving unit  
page 89

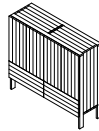

ELFRIEDE  
cabinet  
page 90-91

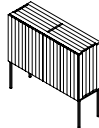

ELFRIEDE  
cabinet on frame  
page 92-93

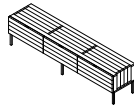

ELFRIEDE  
sideboard  
page 94-95

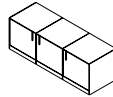

HOTZE  
sideboard  
page 96

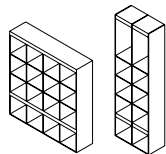

HOTZE  
& HOTZE II  
shelving unit  
page 97

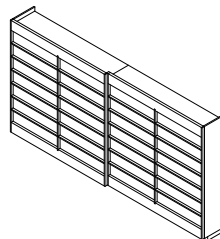

JAAP  
cabinet  
page 98



LUTGARDE  
shelving unit  
page 99

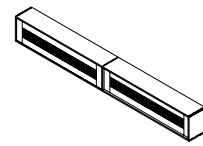

MEINT  
hanging  
sideboard  
page 100

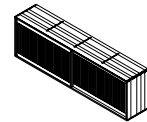

MEINT REIN  
sideboard  
page 101-102



STIJN  
shelving unit  
page 103

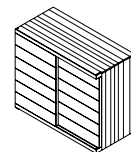

SYM  
cabinet  
page 104

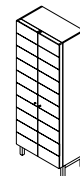

0208 SYM  
cabinet  
page 105



# BEREND cabinet series

design: Gjalt Pilat, 2023

prices 2023 in euro excl. VAT

no customization possible  
**dimensions**      **W x D x H**

**body**  
 example: 23cm high,  
 3 compartments wide

**base**  
 example: low model 30 cm,  
 1320 wide (3 compartments)

complete

indication of the  
 (start) position of the body

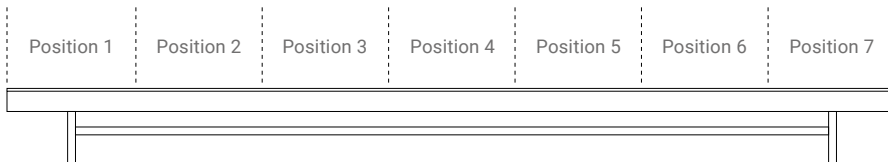
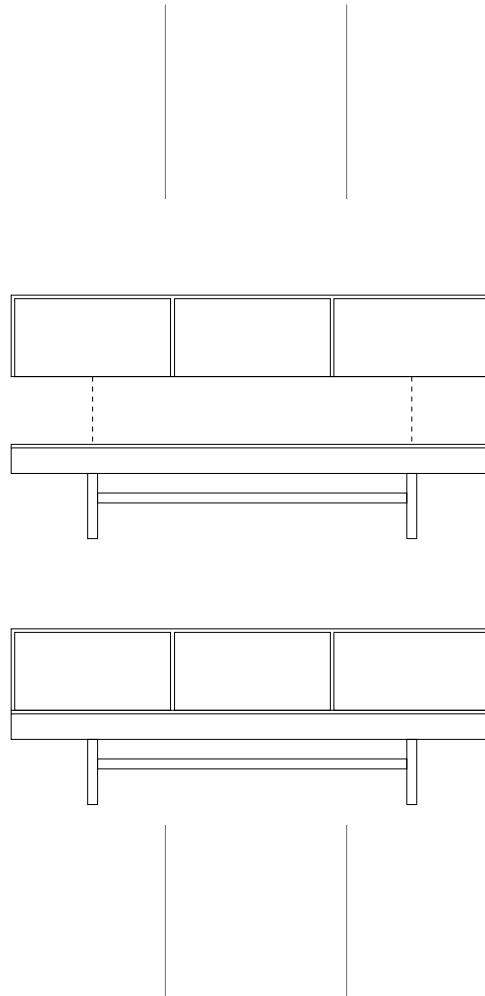

## key features / additional prices

- a Berend cabinet can be composed using 2 different parts:
- 2 heights base frames:**  
 low: 300 mm or high: 500 mm
- 3 heights of body parts:**  
 1 = 230 mm high (equipped with flaps),  
 2 = 440 mm (equipped with doors)  
 3 = 865 mm high (equipped with doors)
- sizes and prices of the various width measurements made insightful on the next 5 pages
- finishing possibilities according to the solid wood samples as presented in a current sample box
- the prices are the same for all finishes; soap, oil, stain-lacquer, transparant lacquer and color lacquer.

## To order

- in addition to the chosen wood type and finish we require the following information for proper order processing:
  1. width of the Base (number of compartments)
  2. height of the Base (300/500mm)
  3. width of the body (number of compartments)
  4. height of the body (230/440/865mm)
  5. position where cabinet body should start
  6. by default, the wooden part of the base is not in the color of the steel frame. Entire base in one color? Then indicate this when ordering.
  7. For body heights 440 and 865 indicate how the doors should open, left-handed or right-handed. Indicate with the following symbols:

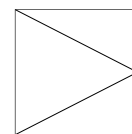

opens to the left

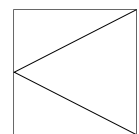

opens to the right

# BEREND base 30 cm high

design: Gjalt Pilat, 2023

prices 2023 in euro excl. VAT

*no customization possible*

## dimensions

## W x D x H

Berend cabinet base LOW  
300 MM HIGH



base 2 compartments wide 890 x 400 x 300

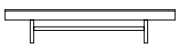

base 3 compartments wide 1320 x 400 x 300

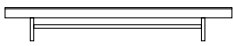

base 4 compartments wide 1750 x 400 x 300

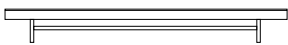

base 5 compartments wide 2180 x 400 x 300

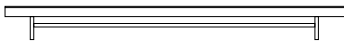

base 6 compartments wide 2610 x 400 x 300



base 7 compartments wide 3040 x 400 x 300

## beech

## light elm

## oak

## walnut

## key features / additional prices

926

1.000

1.075

1.074

1.160

1.247

1.200

1.296

1.393

1.376

1.486

1.598

1.557

1.681

1.807

1.709

1.845

1.984

- the base is constructed from a steel frame with a wooden top
- by default the wooden part of the base is not sprayed in the same color of the frame.
- if the wooden part of the base has to be spraypainted in the same color as the steel frame, please indicate this separately when ordering
- base with coating in the standard colors RAL 9004 (black), RAL 9010 (white), Sikkens C4.40.30 (red), F6.05.50 (taupe) or E4.40.40 (caramel). Alternative colors are possible on request
- a base of 7 compartments wide stands on 6 feet
- finishing possibilities according to the solid wood samples as presented in a current sample box
- the prices are the same for all finishes; soap, oil, stain-lacquer, transparant lacquer and color lacquer.

# BEREND base 50 cm high

design: Gjalt Pilat, 2023

prices 2023 in euro excl. VAT

*no customization possible*

## dimensions

## W x D x H

Berend base HIGH  
500 MM HOOG

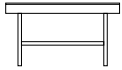

base 2 compartments wide 890 x 400 x 500



base 3 compartments wide 1320 x 400 x 500

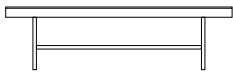

base 4 compartments wide 1750 x 400 x 500

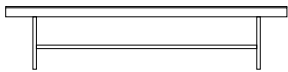

base 5 compartments wide 2180 x 400 x 500

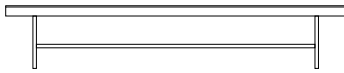

base 6 compartments wide 2610 x 400 x 500

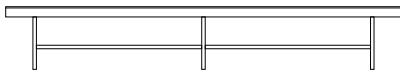

base 7 compartments wide 3040 x 400 x 500

## beech

## light elm

## oak

## walnut

## key features / additional prices

926

1.000

1.075

1.074

1.160

1.247

1.200

1.296

1.393

1.376

1.486

1.598

1.557

1.681

1.807

1.709

1.845

1.984

- the base is constructed from a steel frame with a wooden top
- by default the wooden part of the base is not sprayed in the same color of the frame.
- if the wooden part of the base has to be spraypainted in the same color as the steel frame, please indicate this separately when ordering
- base with coating in the standard colors RAL 9004 (black), RAL 9010 (white), Sikkens C4.40.30 (red), F6.05.50 (taupe) or E4.40.40 (caramel). Alternative colors are possible on request
- a base of 7 compartments wide stands on 6 feet
- finishing possibilities according to the solid wood samples as presented in a current sample box
- the prices are the same for all finishes; soap, oil, stain-lacquer, transparant lacquer and color lacquer.

# BEREND body 23 cm high

design: Gjalt Pilat, 2023

prices 2023 in euro excl. VAT

*no customization possible*

## dimensions

## W x D x H

Berend body with flaps  
230 MM HIGH



1 compartment wide 460 x 400 x 230



2 compartments wide 890 x 400 x 230



3 compartments wide 1320 x 400 x 230



4 compartments wide 1750 x 400 x 230



5 compartments wide 2180 x 400 x 230



6 compartments wide 2610 x 400 x 230



7 compartments wide 3040 x 400 x 230

## beech

### light elm

### oak

### walnut

## key features / additional prices

- body elements with flaps
- net depth in the compartments: 35.5 cm
- finishing possibilities according to the solid wood samples as presented in a current sample box
- the prices are the same for all finishes; soap, oil, stain-lacquer, transparent lacquer and color lacquer.

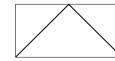

flap(s) open downwards

# BEREND body 44 cm high

design: Gjalt Pilat, 2023

prices 2023 in euro excl. VAT

*no customization possible*

## dimensions

W x D x H

Berend body with doors

**440 MM HIGH**



1 compartment wide 460 x 400 x 440



2 compartments wide 890 x 400 x 440

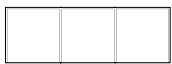

3 compartments wide 1320 x 400 x 440

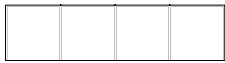

4 compartments wide 1750 x 400 x 440

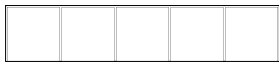

5 compartments wide 2180 x 400 x 440



6 compartments wide 2610 x 400 x 440

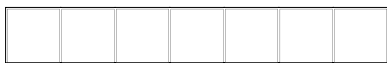

7 compartments wide 3040 x 400 x 440

**beech**

**light elm**

**oak**

**walnut**

**key features / additional prices**

967

1.044

1.201

1.338

1.445

1.662

1.758

1.898

2.183

2.271

2.452

2.820

2.905

3.138

3.608

3.609

3.898

4.482

4.323

4.669

5.370

- body elements with doors

- net depth in the compartments: 35.5 cm

- finishing possibilities according to the solid wood samples as presented in a current sample box

- the prices are the same for all finishes; soap, oil, stain-lacquer, transparent lacquer and color lacquer.

- When ordering, indicate how the doors must open, left-handed or right-handed.

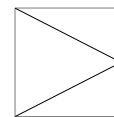

to the left

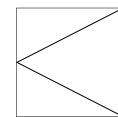

to the right

# BEREND body 86,5 cm high

design: Gjalt Pilat, 2023

prices 2023 in euro excl. VAT

no customization possible

## dimensions

## W x D x H

Berend body with doors  
865 MM HIGH



1 compartment wide 460 x 400 x 865

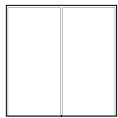

2 compartments wide 890 x 400 x 865



3 compartments wide 1320 x 400 x 865

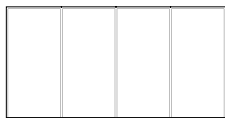

4 compartments wide 1750 x 400 x 865

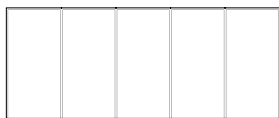

5 compartments wide 2180 x 400 x 865



6 compartments wide 2610 x 400 x 865



7 compartments wide 3040 x 400 x 865

## beech

## light elm

## oak

## walnut

## key features / additional prices

- body elements with doors
- net depth in the compartments: 35.5 cm
- finishing possibilities according to the solid wood samples as presented in a current sample box
- the prices are the same for all finishes; soap, oil, stain-lacquer, transparent lacquer and color lacquer.
- When ordering, indicate how the doors must open, left-handed or right-handed.

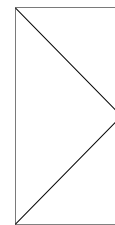

to the left

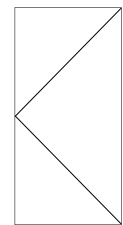

to the right

1.203

1.300

1.495

1.654

1.786

2.054

2.132

2.303

2.648

2.721

2.939

3.380

3.498

3.778

4.345

4.347

4.695

5.399

5.193

5.609

6.450

# BEREND cabinet series examples

design: Gjalt Pilat, 2023

prices 2023 in euro excl. VAT

no customization possible

**dimensions**                      **W x D x H**

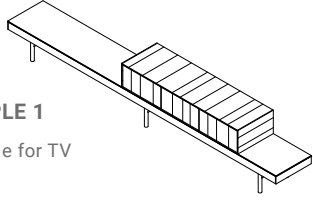

## EXAMPLE 1

side table for TV

total dimensions                      3040 x 400 x 530

### To order as:

1. width of base 3040 (7 compartments)
2. hight base 300
3. body 1320 wide (3 compartments)
4. body 230 high
5. body starting on position 4
6. base in one color: yes

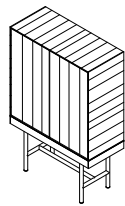

## EXAMPLE 2

cabinet

total dimensions                      890 x 400 x 1365

### To order as:

1. width of base 890 (2 compartments)
2. hight base 500
3. body 890 wide (2 compartments)
4. body 865 high
5. body starting on position 1
6. base in one color: no
7. door 1: left, door 2: right

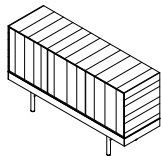

## EXAMPLE 3

sideboard

total dimensions                      1320 x 400 x 740

### To order as:

1. width of base 1320 (3 compartments)
2. hight base 300
3. body 1320 wide (3 compartments)
4. body 440 high
5. body starting on position 1
6. base in one color: yes
7. door 1: left, door 2: left, door 3: to the right.

**beech**  
**light elm**                      **oak**                      **walnut**

BASE	BASE	BASE
1.709	1.845	1.984
BODY	BODY	BODY
1.425	1.539	1.770
TOTAL	TOTAL	TOTAL
3.134	3.384	3.754

BASE	BASE	BASE
926	1.000	1.075
BODY	BODY	BODY
1.654	1.786	2.054
TOTAL	TOTAL	TOTAL
2.580	2.786	3.129

BASE	BASE	BASE
1.074	1.160	1.247
BODY	BODY	BODY
1.758	1.898	2.183
TOTAL	TOTAL	TOTAL
2.832	3.058	3.430

## key features / additional prices

- in addition to the chosen wood type and finish we require the following information for proper order processing:
  1. width of the base (number of compartments)
  2. height of the base (300/500mm)
  3. width of the body (number of compartments)
  4. height of the body (230/440/865mm)
  5. position where cabinet body should start
  6. by default, the wooden part of the base is not in the color of the steel frame. Entire base in one color? Then indicate this when ordering.
  - 7. For body heights 440 and 865 indicate how the doors should open, left-handed or right-handed. Indicate with the following symbols:

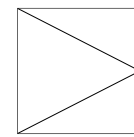

opens to the left

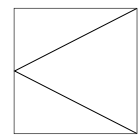

opens to the right

- Beside are some price examples including order formulation

# DIEDERIK kast

design: Gjalt Pilat, 2004

prices 2023 in euro excl. VAT

*custom sizes on request*

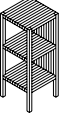
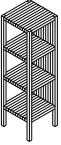
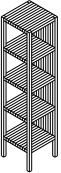
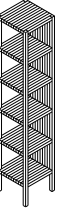
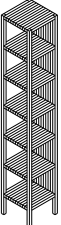
dimensions	W x D x H	beech			key features / additional prices
		light elm	oak	walnut	
Diederik 1-compartment	36 x 36 x 56	655	707	813	<ul style="list-style-type: none"> <li>• made of 3 x 3 cm solid wood</li> <li>• compartments of 30 x 30 x 30 cm</li> <li>• finishing possibilities according to the solid wood samples as presented in a current sample box</li> <li>• The prices are the same for all finishes; soap, oil, stain-lacquer, transparant lacquer and color lacquer.</li> </ul>
					
Diederik 2-compartments	36 x 36 x 89	887	958	1.102	
					
Diederik 3-compartments	36 x 36 x 122	1.119	1.209	1.390	
					
Diederik 4-compartments	36 x 36 x 155	1.398	1.509	1.736	
					
Diederik 5-compartments	36 x 36 x 188	1.584	1.711	1.967	
					
Diederik 6-compartments	36 x 36 x 221	1.817	1.962	2.257	
					



# EDWARD shelving unit

design: Gjalt Pilat, 2017 / 2022

prices 2023 in euro excl. VAT

no customization possible

Edward compartments

Edward uprights

3 x 33 x 147

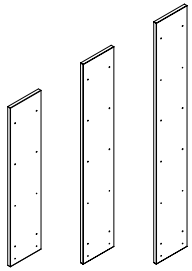

3 x 33 x 185

3 x 33 x 223

Edward shelf 30 width

30 x 32 x 3



Edward shelf 63 width

63 x 32 x 3

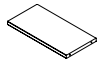

Edward shelving unit

**price example**

267 x 33 x 185

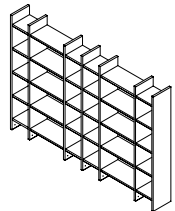

Edward shelving unit

**price example**

102 x 33 x 223

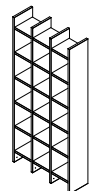

	beech	light elm	oak	walnut	mdf
Edward uprights 3 x 33 x 147	256	277	318	318	249
Edward uprights 3 x 33 x 185	295	318	366	366	284
Edward uprights 3 x 33 x 223	327	353	406	406	315
Edward shelf 30 width	83	90	104	104	76
Edward shelf 63 width	118	127	146	146	111

## key features / additional prices

- Height 147, 185 or 223 cm
- Shelves and uprights 3 cm thick
- Width shelves 30 or 63 cm
- Standard height between the shelves is 35 cm
- finishing possibilities according to the solid wood samples as presented in a current sample box
- The prices are the same for all finishes; soap, oil, stain-lacquer, transparent lacquer and color lacquer.

compartment	wood type	price	amount	sub total
upright 185	light elm	295	7	2.065
shelf 30	light elm	83	20	1.660
shelf 63	light elm	118	10	1.180
<b>total</b>				<b>4.905</b>





compartment	wood type	price	amount	sub total
upright 223	MDF	315	4	1.260
shelf 30	MDF	76	18	1.368
<b>total</b>				<b>2.628</b>

# EIRIK cupboard/shelving unit

design: Peter Tromop, 2007

prices 2023 in euro excl. VAT

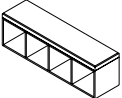
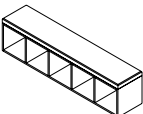
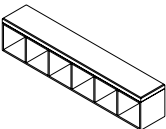
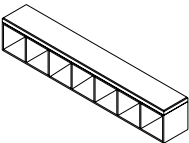
custom sizes on request

dimensions	W x D x H	light elm	oak	walnut	key features / additional prices
	30 x 30 x 34,5	355	383	441	• 2 x wall mount, additional price 34,- euro
	58,5 x 30 x 34,5	544	588	676	• 2 x wall mount, additional price 34,- euro
	87 x 30 x 34,5	734	793	912	• 2 x wall mount, additional price 34,- euro
	115,5 x 30 x 34,5	925	999	1.149	• 3 x wall mount, additional price 48,- euro
	144 x 30 x 34,5	1.115	1.204	1.385	• 3 x wall mount, additional price 48,- euro
	172,5 x 30 x 34,5	1.304	1.408	1.619	• 4 x wall mount, additional price 62,- euro
	201 x 30 x 34,5	1.496	1.615	1.857	• 4 x wall mount, additional price 62,- euro
	Eirik cupboard doors per compartment	96	104	120	<ul style="list-style-type: none"> <li>• Eirik cupboard / shelving unit is supplied as standard on felt, for wall mounting the above-mentioned surcharge applies</li> <li>• doors are suitable for the models on this page</li> <li>• finishing possibilities according to the solid wood samples as presented in a current sample box</li> <li>• The prices are the same for all finishes; soap, oil, stain-lacquer, transparent lacquer and color lacquer.</li> </ul>

# ELFRIEDE cabinet/sideboard

design: Gjalt Pilat / Peter Tromop 2018

prices 2023 in euro excl. VAT

no customization possible

## dimensions

## W x D x H

## beech

## light elm

## oak

## walnut

## key features / additional prices

1 compartment wide,  
2 compartments  
high



66 x 39,5 x 70,5  
66 x 46 x 70,5  
66 x 53 x 70,5

1.436  
1.459  
1.565

1.551  
1.575  
1.690

1.784  
1.812  
1.944

- the mentioned depth is that of the body
- the lower shelf is fixed to the body, other shelves are height-adjustable
- height of legs is 20 cm, equipped with adjustable legs
- completely made of 2,2 cm thick wood
- drawer boxes sizes: approx. 58 x 31 x 14 cm,
- color anthracite. drawers are push to open, fully extendable and can only be placed in bottom position.
- doors with cup handles on top
- prices include rear wall
- finishing possibilities according to the solid wood samples as presented in a current sample box
- The prices are the same for all finishes; soap, oil, stain-lacquer, transparent lacquer and color lacquer.

1 compartment wide,  
3 compartments  
high

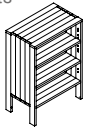

66 x 39,5 x 95  
66 x 46 x 95  
66 x 53 x 95

1.500  
1.544  
1.655

1.620  
1.667  
1.788

1.863  
1.917  
2.056

1 compartment wide,  
4 compartments  
high

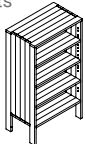

66 x 39,5 x 119  
66 x 46 x 119  
66 x 53 x 119

1.563  
1.630  
1.745

1.689  
1.760  
1.884

1.942  
2.024  
2.167

2 compartments wide,  
2 compartments  
high

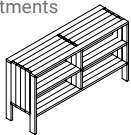

130 x 39,5 x 70,5  
130 x 46 x 70,5  
130 x 53 x 70,5

1.770  
1.804  
1.894

1.911  
1.948  
2.046

2.198  
2.241  
2.353

2 compartments wide,  
3 compartments  
high

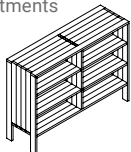

130 x 39,5 x 95  
130 x 46 x 95  
130 x 53 x 95

1.865  
1.921  
2.025

2.014  
2.075  
2.187

2.316  
2.386  
2.515

2 compartments wide,  
4 compartments  
high

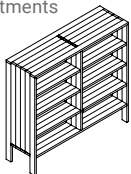

130 x 39,5 x 119  
130 x 46 x 119  
130 x 53 x 119

1.968  
2.045  
2.157

2.126  
2.208  
2.330

2.445  
2.540  
2.679

drawer unit  
price



225

243

268

doors price  
per set



2 compartments high  
3 compartments high  
4 compartments high

276  
296  
315

298  
319  
340

343  
367  
391

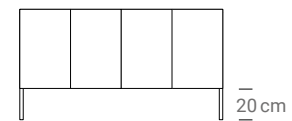

# ELFRIEDE cabinet/sideboard

design: Gjal't Pilat / Peter Tromop 2018

prices 2023 in euro excl. VAT

no customization possible

## dimensions

## W x D x H

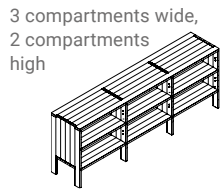

3 compartments wide,  
2 compartments  
high

193,5 x 39,5 x 70,5  
193,5 x 46 x 70,5  
193,5 x 53 x 70,5

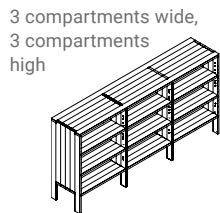

3 compartments wide,  
3 compartments  
high

193,5 x 39,5 x 95  
193,5 x 46 x 95  
193,5 x 53 x 95

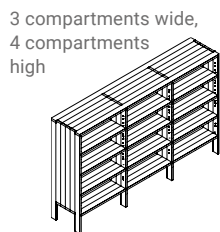

3 compartments wide,  
4 compartments  
high

193,5 x 39,5 x 119  
193,5 x 46 x 119  
193,5 x 53 x 119

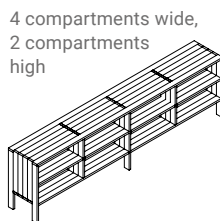

4 compartments wide,  
2 compartments  
high

257,5 x 39,5 x 70,5  
257,5 x 46 x 70,5  
257,5 x 53 x 70,5

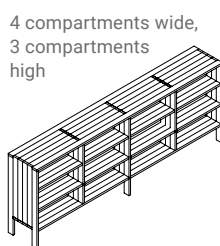

4 compartments wide,  
3 compartments  
high

257,5 x 39,5 x 95  
257,5 x 46 x 95  
257,5 x 53 x 95

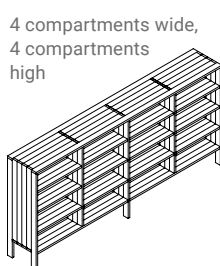

4 compartments wide,  
4 compartments  
high

257,5 x 39,5 x 119  
257,5 x 46 x 119  
257,5 x 53 x 119



drawer unit  
price



doors price  
per set



2 compartments high

3 compartments high

4 compartments high

## beech

## light elm

## oak

## walnut

## key features / additional prices

2.103

2.271

2.612

- the mentioned depth is that of the body

2.150

2.322

2.670

- the lower shelf is fixed to the body, other shelves are height-adjustable

2.222

2.400

2.759

- height of legs is 20 cm, equipped with adjustable legs

2.232

2.411

2.772

- completely made of 2,2 cm thick wood

2.298

2.482

2.855

- drawer boxes sizes: approx. 58 x 31 x 14 cm,

2.395

2.587

2.975

- color anthracite. drawers are push to open, fully extendable and can only be placed in bottom position.

2.463

2.660

3.059

- doors with cup handles on top

2.548

2.752

3.165

- prices include rear wall

2.653

2.866

3.295

- finishing possibilities according to the solid wood samples as presented in a current sample box

2.437

2.632

3.026

- The prices are the same for all finishes;

2.495

2.695

3.099

- soap, oil, stain-lacquer, transparent

2.550

2.754

3.167

- lacquer and color lacquer.

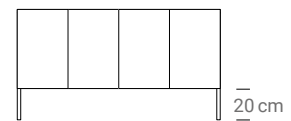

20 cm

225

243

268

276

298

343

296

319

367

315

340

391

# ELFRIEDE cabinet/sideboard on frame

design: Gjalt Pilat / Peter Tromop 2018

prices 2023 in euro excl. VAT

no customization possible

## dimensions

## W x D x H

## beech

## light elm

## oak

## walnut

## key features / additional prices

1 compartment wide,  
2 compartments  
high

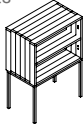

66 x 39,5 x 95,5  
66 x 46 x 95,5  
66 x 53 x 95,5

1.702  
1.725  
1.832

1.838  
1.863  
1.978

2.114  
2.142  
2.275

- the mentioned depth is that of the body
- the lower shelf is fixed to the body, other shelves are height-adjustable
- completely made of 2,2 cm thick wood
- drawer boxes sizes: approx. 58 x 31 x 14 cm, color anthracite. drawers are push to open, fully extendable and can only be placed in bottom position.
- doors with cup handles on top
- prices include rear wall
- finishing possibilities according to the solid wood samples as presented in a current sample box
- The prices are the same for all finishes; soap, oil, stain-lacquer, transparent lacquer and color lacquer.
- a metal frame has a height of 45 cm
- metal feet are adjustable
- Frame with coating in the standard colors RAL 9004 (black), RAL 9010 (white), Sikkens C4.40.30 (red), F6.05.50 (taupe) or E4.40.40 (caramel). Alternative colors are available on request

1 compartment wide,  
3 compartments  
high

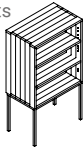

66 x 39,5 x 120  
66 x 46 x 120  
66 x 53 x 120

1.778  
1.802  
1.914

1.921  
1.947  
2.067

2.209  
2.239  
2.377

1 compartment wide,  
4 compartments  
high

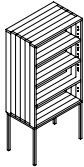

66 x 39,5 x 144  
66 x 46 x 144  
66 x 53 x 144

1.858  
1.883  
2.000

2.007  
2.034  
2.160

2.308  
2.339  
2.484

2 compartment wide,  
2 compartments  
high

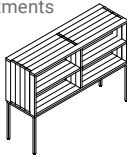

130 x 39,5 x 95,5  
130 x 46 x 95,5  
130 x 53 x 95,5

2.138  
2.174  
2.262

2.310  
2.348  
2.443

2.656  
2.700  
2.810

2 compartment wide,  
3 compartments  
high

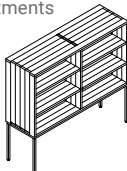

130 x 39,5 x 120  
130 x 46 x 120  
130 x 53 x 120

2.235  
2.291  
2.395

2.413  
2.474  
2.586

2.776  
2.845  
2.974

2 compartment wide,  
4 compartments  
high

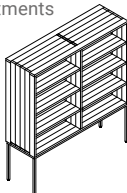

130 x 39,5 x 144  
130 x 46 x 144  
130 x 53 x 144

2.337  
2.414  
2.527

2.524  
2.607  
2.729

2.903  
2.999  
3.138

drawer unit  
price



225

243

268

doors price  
per set



2 compartments high  
3 compartments high  
4 compartments high

276  
296  
315

298  
319  
340

343  
367  
391

### • METAL FRAME 4 LEGS (with width 130)

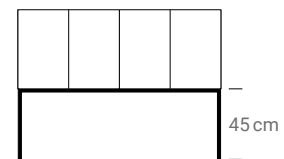

### • METAL FRAME 6 LEGS (with width 257.5)

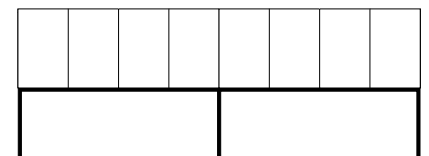

# ELFRIEDE cabinet/sideboard on frame

design: Gjalt Pilat / Peter Tromop 2018

prices 2023 in euro excl. VAT

no customization possible

## dimensions

## W x D x H

3 compartment wide,  
2 compartments  
high

193,5 x 39,5 x 95,5  
193,5 x 46 x 95,5  
193,5 x 53 x 95,5

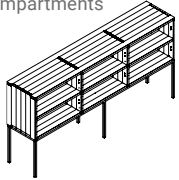

3 compartment wide,  
3 compartments  
high

193,5 x 39,5 x 120  
193,5 x 46 x 120  
193,5 x 53 x 120

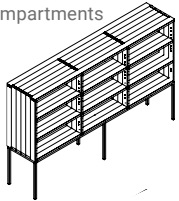

3 compartment wide,  
4 compartments  
high

193,5 x 39,5 x 144  
193,5 x 46 x 144  
193,5 x 53 x 144

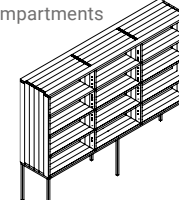

4 compartment wide,  
2 compartments  
high

257,5 x 39,5 x 95,5  
257,5 x 46 x 95,5  
257,5 x 53 x 95,5

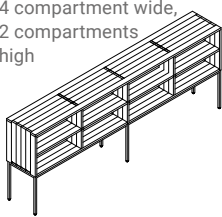

4 compartment wide,  
3 compartments  
high

257,5 x 39,5 x 120  
257,5 x 46 x 120  
257,5 x 53 x 120

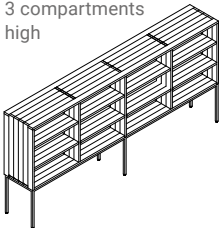

4 compartment wide,  
4 compartments  
high

257,5 x 39,5 x 144  
257,5 x 46 x 144  
257,5 x 53 x 144

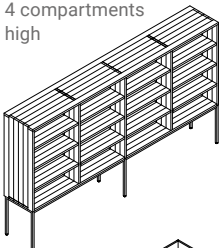

drawer unit  
price



doors price  
per set



2 compartments high  
3 compartments high  
4 compartments high

## beech

### light elm

### oak

### walnut

## key features / additional prices

2.575  
2.621  
2.694

2.781  
2.831  
2.909

3.198  
3.256  
3.346

2.781  
2.849  
2.946

3.004  
3.077  
3.182

3.454  
3.539  
3.659

3.014  
3.099  
3.204

3.255  
3.346  
3.461

3.744  
3.848  
3.980

3.012  
3.070  
3.125

3.253  
3.316  
3.375

3.741  
3.813  
3.881

3.330  
3.408  
3.497

3.596  
3.681  
3.777

4.136  
4.233  
4.344

3.691  
3.784  
3.880

3.986  
4.086  
4.190

4.584  
4.699  
4.819

225

243

268

276

298

343

296

319

367

315

340

391

- the mentioned depth is that of the body
- the lower shelf is fixed to the body, other shelves are height-adjustable
- completely made of 2,2 cm thick wood
- drawer boxes sizes: approx. 58 x 31 x 14 cm, color anthracite. drawers are push to open, fully extendable and can only be placed in bottom position.
- doors with cup handles on top
- prices include rear wall
- finishing possibilities according to the solid wood samples as presented in a current sample box
- The prices are the same for all finishes; soap, oil, stain-lacquer, transparent lacquer and color lacquer.
- a metal frame has a height of 45 cm
- metal feet are adjustable
- Frame with coating in the standard colors RAL 9004 (black), RAL 9010 (white), Sikkens C4.40.30 (red), F6.05.50 (taupe) or E4.40.40 (caramel). Alternative colors are available on request

### • METAL FRAME 4 LEGS (with width 130)

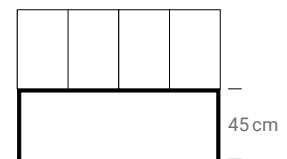

### • METAL FRAME 6 LEGS (with width 257.5)

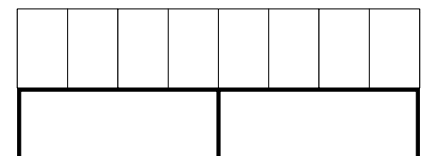

# ELFRIEDE wall table

design: Gjalt Pilat / Peter Tromop 2023

prices 2023 in euro excl. VAT

*custom sizes on request*

## dimensions

## W x D x H

Elfriede wall table

1 compartment wide 60 x 39,5 x 46,4

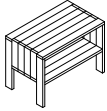

Elfriede wall table

2 compartments wide 130 x 39,5 x 46,4

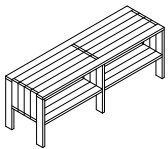

Elfriede wall table

3 compartments wide 193,5 x 39,5 x 46,4

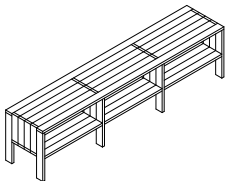

Elfriede wall table

4 compartments wide 257,5 x 39,5 x 46,4

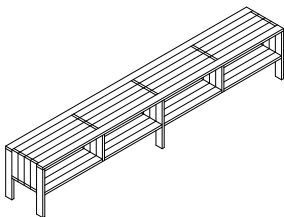

Elfriede wall table flap

65,6 x 26,4 x 22



## beech

## light elm

## oak

## walnut

## key features / additional prices

1.279

1.381

1.588

- the mentioned depth is that of the body
- height of legs is 20 cm, equipped with adjustable legs
- completely made of 2,2 cm thick wood
- flaps with cup handles on top
- prices include rear wall
- finishing possibilities according to the solid wood samples as presented in a current sample box
- The prices are the same for all finishes; soap, oil, stain-lacquer, transparent lacquer and color lacquer.

1.567

1.692

1.946

1.851

1.999

2.299

2.181

2.355

2.708

187

202

233

# ELFRIEDE wall table on frame

design: Gjal't Pilat / Peter Tromop 2023

prices 2023 in euro excl. VAT

*custom sizes on request*

## dimensions

## W x D x H

## beech

## light elm

## oak

## walnut

## key features / additional prices

Elfriede wall table

on frame

60 x 39,5 x 46,4

1.577

1.703

1.959

1 compartment wide

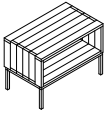

Elfriede wall table

on frame

130 x 39,5 x 46,4

1.986

2.145

2.467

2 compartments wide

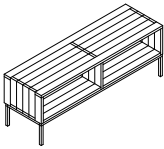

Elfriede wall table

on frame

193,5 x 39,5 x 46,4

2.413

2.606

2.996

3 compartments wide

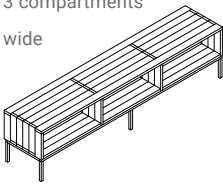

Elfriede wall table

on frame

257,5 x 39,5 x 46,4

2.818

3.044

3.500

4 compartments wide

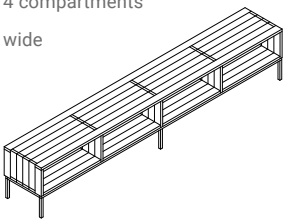

Elfriede wall table flap

65,6 x 26,4 x 22

187

202

233



- the mentioned depth is that of the body
- completely made of 2,2 cm thick wood
- flaps with cup handles on top
- prices include rear wall
- a metal frame has a height of 20 cm
- metal feet are adjustable
- Frame with coating in the standard colors RAL 9004 (black), RAL 9010 (white), Sikkens C4.40.30 (red), F6.05.50 (taupe) or E4.40.40 (caramel). Alternative colors are available on request
- finishing possibilities according to the solid wood samples as presented in a current sample box
- The prices are the same for all finishes; soap, oil, stain-lacquer, transparent lacquer and color lacquer.



# HOTZE II sideboard

design: Gjalt Pilat, 2002/2010

prices 2023 in euro excl. VAT

*custom sizes on request*

## dimensions

## W x D x H

Hotze II hanging sideboard 150 x 30 x 50  
solid wood body 150 x 40 x 50

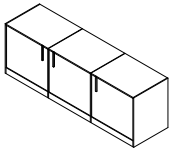

200 x 30 x 50  
200 x 40 x 50

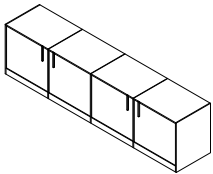

250 x 30 x 50  
250 x 40 x 50

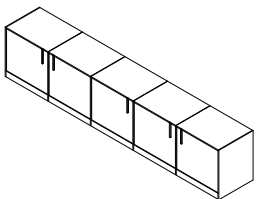

## beech

## light elm

## oak

## walnut

3.111

3.359

3.863

3.250

3.510

4.036

3.379

3.649

4.196

3.560

3.845

4.422

3.584

3.871

4.451

3.873

4.183

4.810



## key features / additional prices

- thickness of wood 1 / 6 cm
- behind every door is a shelf of 1 cm thick
- the shelves are placeable in five positions, each with 3,2 cm distance
- wall mounting by means of a mounting rail that is included
- The Hotze II hangs approx. 6 mm away from the wall
- doors 1,9 cm thick MDF spraypainted in a colour of your choice
- The finishing options are according to the solid wood samples such as presented in the current sample box.
- The prices are the same for all finishes; soap, oil, stain-lacquer, transparant lacquer and color lacquer.

# HOTZE shelving unit

design: Gjalt Pilat, 2002/2010

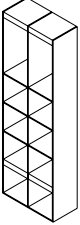
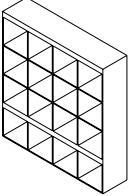
prices 2023 in euro excl. VAT

		beech			mdf	key features / additional prices
dimensions	W x D x H	light elm	oak	walnut		
Hotze shelving unit	63 x 30 x 197	1.405	1.518	1.745		<ul style="list-style-type: none"> <li>• material thickness 1/6 cm</li> <li>• wall mounting by means of a mounting rail that is included</li> <li>• at a Hotze sprayed in a color, based on the beech/light elm price</li> <li>• doors MDF sprayed in epoxy lacquer in a RAL or Sikkens colour, except metallics and fluorescent paints</li> <li>• doors 1,9 cm thick, MDF spraypainted in a colour of your choice</li> <li>• The finishing options are according to the solid wood samples such as presented in the current sample box.</li> <li>• The prices are the same for all finishes; soap, oil, stain-lacquer, transparant lacquer and color lacquer.</li> </ul>
						
	125 x 30 x 135	2.252	2.432	2.797		
						
	additional price door 30 x 30				152	
	additional price door 30 x 61				229	

# JAAP cabinet

design: Gjal't Pilat, 2004

prices 2023 in euro excl. VAT

*custom sizes on request*

## dimensions

## W x D x H

## light elm

## oak

## walnut

## key features / additional prices

Jaap cabinet 240

240 x 42 x 192

8.294

8.958

10.301

(completely solid wood)

240 x 42 x 192

6.373

6.883

7.571

(body mdf)

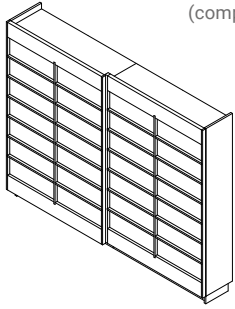

Jaap cabinet 300

300 x 42 x 192

9.649

10.421

11.984

(completely solid wood)

300 x 42 x 192

7.366

7.955

8.751

(body mdf)

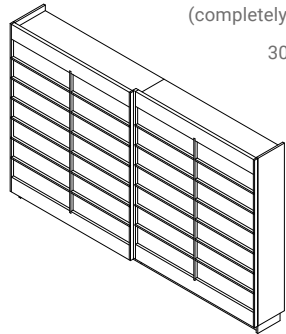

Jaap cabinet 345

345 x 42 x 192

10.058

10.863

12.492

(completely solid wood)

345 x 42 x 192

7.588

8.195

9.014

(body mdf)

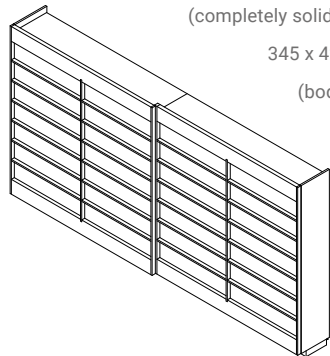

- frame sliding door solid wood, doorpanel and backpanel MDF spraypainted in a colour of choice
- depth of shelves 31,5 cm
- the Jaap cabinet is dismountable
- sliding doors have an integrated brake and closing system
- The finishing options are according to the solid wood samples such as presented in the current sample box.
- The prices are the same for all finishes; soap and / or oil, stain-lacquer, transparant lacquer and color lacquer.
- layout Jaap cabinet:

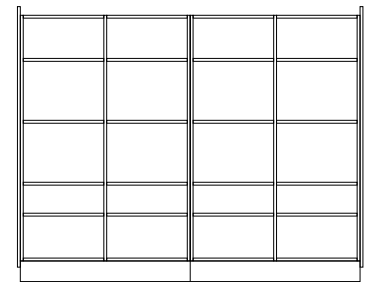

# LUTGARDE shelving unit

design: Gjalt Pilat, 2018

prices 2023 in euro excl. VAT

*no customization possible*

## dimensions

## W x D x H

Lutgarde shelving unit

33 x 33 x 107

33 x 33 x 147

33 x 33 x 187

33 x 33 x 227

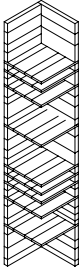

## beech

### light elm

### oak

### walnut

## key features / additional prices

1.257

1.358

1.562

1.505

1.625

1.869

1.712

1.849

2.126

1.947

2.103

2.418

- vertical parts are 3 cm thick, shelves are 1,5 cm thick.
- equipped with adjustable feet
- The finishing options are according to the solid wood samples such as presented in the current sample box.
- The prices are the same for all finishes; soap and / or oil, stain-lacquer, transparent lacquer and color lacquer.

# MEINT hanging sideboard

design: Gjalt Pilat, 2005

prices 2023 in euro excl. VAT

*custom sizes on request*

## dimensions

## W x D x H

Meint hanging sideboard	175 x 30 x 40
	225 x 30 x 40
	275 x 30 x 40
	325 x 30 x 40

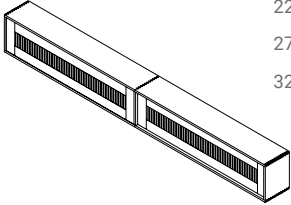

## beech

## light elm

## oak

## walnut

2.130	2.300	2.645
2.293	2.477	2.848
2.507	2.708	3.114
2.668	2.881	3.314

## key features / additional prices

- sliding doors
- height adjustable shelves, depth of shelf 23 cm
- wall mounting by means of a mounting rail that is included
- The Meint hanging cabinet is hanging approx. 6 mm from the wall
- The finishing options are according to the solid wood samples such as presented in the current sample box.
- The prices are the same for all finishes; soap and / or oil, stain-lacquer, transparant lacquer and color lacquer.

# MEINT REIN hanging sideboard

design: Gjalt Pilat, 2010

prices 2023 in euro excl. VAT

*custom sizes on request*

## dimensions

## W x D x H

## light elm

## oak

## walnut

## key features / additional prices

Meint Rein  
hanging sideboard

212 x 40 x 64

4.363

4.712

5.419

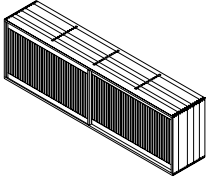

Meint Rein  
hanging sideboard

266 x 40 x 64

4.677

5.052

5.809

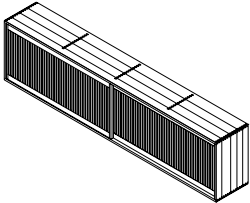

Meint Rein  
hanging sideboard

320 x 40 x 64

4.994

5.393

6.202

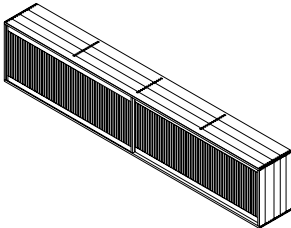

Meint Rein  
hanging sideboard

374 x 40 x 64

5.309

5.734

6.594

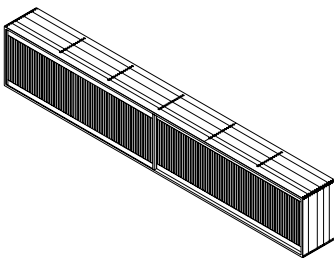

- the hull is based on the Meint sideboard
- 2 large sliding doors are from the Rein cabinet
- the Meint Rein is available in 2 variations: as a hanging sideboard mounted on the wall and as a standing sideboard on a frame (see next page)
- The Meint Rein hanging cabinet is hanging approx. 6 mm from the wall
- height hull 64 cm
- 32 cm deep shelves are height adjustable, one behind every door
- The Meint Rein has an MDF back wall in RAL or Sikkens color of your choice.
- The finishing options are according to the solid wood samples such as presented in the current sample box.
- The prices are the same for all finishes; soap and / or oil, stain-lacquer, transparent lacquer and color lacquer.

# MEINT REIN sideboard on frame

design: Gjalt Pilat, 2010

prices 2023 in euro excl. VAT

*custom sizes on request*

## dimensions

## W x D x H

## light elm

## oak

## walnut

## key features / additional prices

Meint Rein  
sideboard on frame

212 x 40 x 84

5.116

5.525

6.354

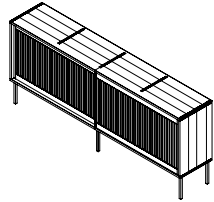

Meint Rein  
sideboard on frame

266 x 40 x 84

5.497

5.936

6.827

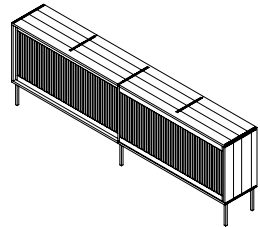

Meint Rein  
sideboard on frame

320 x 40 x 84

5.882

6.352

7.305

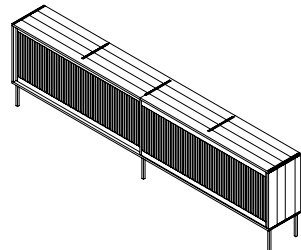

Meint Rein  
sideboard on frame

374 x 40 x 84

6.259

6.760

7.774

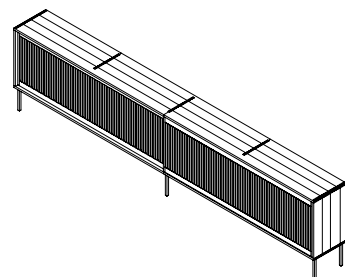

- the hull is based on the Meint sideboard
- 2 large sliding doors are from the Rein cabinet
- the Meint Rein is available in 2 variations: as a standing sideboard on a frame and as a hanging sideboard mounted on the wall (see page before)
- height hull 64 cm
- height frame 20 cm
- 32 cm deep shelves are height adjustable, one behind every door
- The Meint Rein has an MDF back wall in RAL or Sikkens color of your choice.
- Frame with coating in the standard colors RAL 9004 (black), RAL 9010 (white), Sikkens C4.40.30 (red), F6.05.50 (taupe) or E4.40.40 (caramel). Alternative colors are available on request
- The finishing options are according to the solid wood samples such as presented in the current sample box.
- The prices are the same for all finishes; soap and / or oil, stain-lacquer, transparent lacquer and color lacquer.

# STIJN shelving units

design: Gjalt Pilat / Peter Tromp 2020

prices 2023 in euro excl. VAT

no customization possible

## dimensions

W x D x H

light elm

oak

walnut

Stijn basic panel

32 x 4 x 197

270

291

335

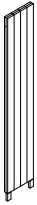

Stijn shelf  
(standard/with accent)

32 x 32 x 4

91

98

113

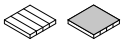

Stijn coat rack element  
for 2 compartments

64 x 10 x 4

155

167

192



Stijn coat rack element  
for 3 compartments

97 x 10 x 4

231

250

287



Wall socket (duo)

price per piece

45



## pricing example

compartment

wood type

price p/p.

amount

sub total

Stijn TV-wall-unit

basic panel

light elm

270

6

1.620

shelf

light elm

91

16

1.456

shelf with accent

light elm

91

8

728

coat rack element

-

-

-

-

wall socket

black

45

1

45

**total**

**3.849**

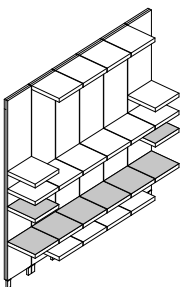

## key features / additional prices

- shelf with accent finish; no additional price
- coat rack element only possible per 2 panels and in combination with 2 shelves
- The finishing options are according to the solid wood samples such as presented in the current sample box.
- The prices are the same for all finishes; soap and / or oil, stain-lacquer, transparent lacquer and color lacquer.
- order form design drawing available via the dealer login on [www.pilat.nl/en/login](http://www.pilat.nl/en/login).  
Look below Image Archive.



# SYM cabinet

design: Gjalt Pilat/Peter Tromop 1999/2008

prices 2023 in euro excl. VAT

*custom sizes on request*

## dimensions

## W x D x H

## light elm

## oak

## walnut

## key features / additional prices

Sym cabinet

159,5 x 50 x 133,5

3.680

3.974

4.570

- back panels MDF in colour of choice

159,5 x 65 x 133,5

3.976

4.294

4.938

- sliding doors with integrated brake and closing system

- is delivered disassembled

- height adjustable shelves:

42,5 cm deep (at depth 50 cm)

52,5 cm deep (at depth 65 cm)

- The finishing options are according

to the solid wood samples such as

presented in the current sample box.

- The prices are the same for all finishes;

soap and / or oil, stain-lacquer,

transparent lacquer and color lacquer.

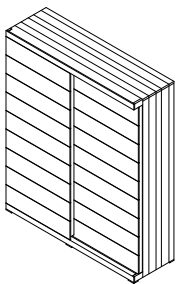
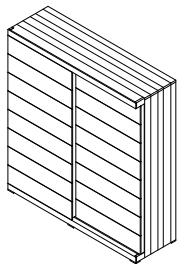
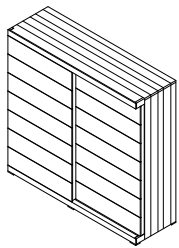
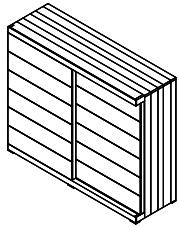

159,5 x 50 x 153,5

3.939

4.254

4.892

159,5 x 65 x 153,5

4.282

4.625

5.318

159,5 x 50 x 173,5

4.131

4.461

5.130

159,5 x 65 x 173,5

4.496

4.856

5.584

159,5 x 50 x 193,5

4.327

4.673

5.374

159,5 x 65 x 193,5

4.746

5.126

5.895

# 0208 SYM cabinet

design: Gjalt Pilat, 2002

prices 2023 in euro excl. VAT

custom sizes on request

## dimensions

0208 SYM cabinet



### W x D x H

80 x 47 x 100

solid wood body

MDF body:

RAL/Sikkens color

### light elm

2.121

1.649

### oak

2.291

1.780

### walnut

2.635

2.110

## key features / additional prices

- doors have an damping effect when closing
- body is dismountable
- cabinet is supplied assembled unless otherwise ordered
- hull is either all solid wood or MDF in RAL or Sikkens color of your choice
- shelves are not height adjustable
- number of shelves at a height of:  
100 cm: 2 / 140 cm: 3 / 220 cm: 4
- The finishing options are according to the solid wood samples such as presented in the current sample box.
- The prices are the same for all finishes; soap and / or oil, stain-lacquer, transparant lacquer and color lacquer.

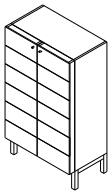

80 x 47 x 140

solid wood body

MDF body:

RAL/Sikkens color

2.887

2.258

3.118

2.439

3.586

2.890

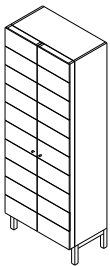

80 x 47 x 220

solid wood body

MDF body:

RAL/Sikkens color

3.877

3.130

4.187

3.381

4.816

3.719



# PILAT & PILAT

## SHOWROOM NL

PILAT&PILAT

Tsjerkebuorren 40

9286 GC Twijzel

+31(0)511 543 981

[pilat@pilat.nl](mailto:pilat@pilat.nl)

[WWW.PILAT.NL](http://WWW.PILAT.NL)